

# price list

2014 V1.1



building forever furniture

# Table of Contents

---

<b>Letter From Our President &amp; CEO</b> .....	ii
<b>General Product and Order Information</b> .....	ii
<b>VISTA Series - Modular Furniture</b> .....	1
Table Overview and Order Information.....	2
Tables .....	4
Overhead Storage .....	11
Privacy Screens.....	13
Work Space Organizers .....	15
Accessories & Electrical .....	16
<b>Pedestals &amp; Accessories</b> .....	18
Pedestals - Ultrapedes (now available with a cushion top).....	19
Table Accessories & Center Drawers .....	21
Ergonomic Accesories .....	22
<b>Storage and Wardrobe Cabinets</b> .....	23
Cabinets and Towers .....	24
Technology Command Centers .....	25
Bookcases (Square Steel Front) .....	27
<b>Lateral Files</b> .....	28
Independence Series .....	29
Bentson Series .....	30
Drawer & Drawer Interiors Options.....	31
Lateral File Accessories .....	32
<b>Vertical Files</b> .....	33
1100 Series .....	34
1400 Series .....	35
3400 Series .....	36
Bentson Series .....	37
Vertical File Accessories.....	38
<b>Desks, Returns, and Credenzas</b> .....	
C-Series .....	39
Spirit Series .....	41
Cube Series.....	44
Contemporary Series .....	47
M-Line Series .....	49
<b>Tables</b> .....	53
Access Series.....	54
Liberty Series.....	54
VISTA Training Series .....	55
Elevation Series .....	56
Drafting Series.....	56
Peninsula Break-away Series .....	56
Contemporary Series .....	57
S-Series.....	58
R-Series.....	58
Freedom Series.....	58
<b>Panel Systems Furniture</b> .....	59
Panels (Powered & Non-Powered) .....	62
Multi-Height Panel Connectors.....	72
Electrical Components .....	73
Worksurfaces.....	74
Support End Panels .....	77
Support Brackets For Worksurfaces.....	78
Overhead Storage .....	79
Wall Mounting Brackets.....	80
Accessories & Task Lights.....	81

Dear Customer:

We are pleased to offer you some of the highest quality office furniture on the market. **Invincible™** Office Furniture Solutions is proud to say our products, including our workstations, filing and storage solutions, systems furniture, and panel systems are 100% U.S. manufactured. **Invincible™**'s legendary "made in America" quality is supported by a century of office furniture manufacturing experience and backed up by our lifetime warranty. When you buy **Invincible™**, you buy "furniture for LIFE . . . guaranteed!"

If by chance you do not find exactly what you are looking for in our catalog, we will be happy to customize a solution to fit your needs. We will do what it takes to make certain you are satisfied.

We look forward to serving you, and to becoming your provider for affordable high quality office furniture solutions.

Sincerely,



James J. Lieser  
President & Chief Executive Officer  
**Invincible™** Office Furniture Solutions



## General Product & Order Information

Customer Service: 920.682.4601  
Toll Free: 877.682.4601  
Fax: 920.683.2970  
Email: Sales@InvincibleFurniture.com  
Website: www.InvincibleFurniture.com  
Office Hours: 8:00 am-4:30 pm CST Mon-Fri

**CREDIT TERMS & PRICING:** This price guide will supersede all other price lists, price quotes, or published information. Contents are subject to change without notice. Prices shown here cover standard product. Changes or alterations to standard products are subject to an additional charge. All pricing, quoting, and invoicing, as well as purchase orders and payments accepted, will be in U.S. dollars only.

**TAXES:** All prices shown in this price list are subject to any Federal, State, and Local taxes.

**FREIGHT & DELIVERY:** All prices are FOB factory. Freight shall be prepaid and allowed to all freight stations in the U.S. mainland states on all standard priced shipments (priced with dealer's standard discount) with a minimum order of \$15,000 list for one standard delivery to one location. On single orders shipped to one location totaling less than \$15,000 list, a flat 8% of the total list price shall be added to the invoice. Contact Invincible™ Customer Service if you have questions or concerns regarding freight. It is not Invincible™'s intent to profit from freight, but rather to simply help to defray delivery expenses.

The factory shall determine the method of shipment, which includes but is not limited to; the determination of the carrier, method of ship-

ment, and routing. For deliveries within 250 miles driving distance of Manitowoc, freight will be figured at 10% of NET, with a \$140 minimum charge (excluding UPS shipments). Standard delivery shall be dock-to-dock delivery and shall occur Monday through Friday, 7:00am - 3:00pm. Any freight expenses over those normally charged by the carrier due to a specific request by the purchaser or consignee (e.g. call before delivery, lift gate required, delivery before 7:00 am or after 3:00 pm, weekend delivery, residential delivery, and school delivery requiring special equipment, etc.), shall be charged back to the dealer of record. Shipments to Canada are FOB factory. Contact factory for freight quote.

For shipments destined for Alaska, Hawaii, U.S. or foreign territories, delivery shall be made to a prearranged port. Customer shall prepay all freight charges and any extra expenses resulting from any request by Customer for after hours, holiday, weekend, or specific time delivery, or special carrier, shipping method (ex: air freight, exclusive use vehicle), packaging &/or routing.

Customer directed or expedited shipments shall be prepaid and billed at actual cost. Any charges arising from failure to meet a shipment, rerouting while in transit or carrier's storage is not included in the pricing shown. A rerouting charge of \$125 shall be assessed for rerouted shipments.

Inside delivery and installation are not included in the pricing shown and are the responsibility of the buyer.

**TRUCKLOADS:** On all individual truckload shipments (except those going to warehouses or to distribution centers), Invincible™ will call the dealer before loading the trailer requesting a firm arrival date. After the

# General Product & Order Information

trailer is loaded, Invincible™ will hold the trailer a maximum of 24 hours without a penalty. After 24 hours the dealer will be assessed \$150 per day, per trailer until the trailer is released. Invincible™ may accept requests to blanket wrap orders. Please consult factory for additional charges that may apply.

If requested by the dealer, we will unload product from the trailer for a later shipment. The charge for this service is \$150 per hour.

**NEW ACCOUNTS:** New customers are required to complete a credit application before orders are accepted. The credit application is available online at [www.InvincibleFurniture.com](http://www.InvincibleFurniture.com). Credit applications are to be submitted to the Accounting Department. All new customers will be required to pay a 50% deposit down with their first order, including freight and fuel surcharges. Balance of the invoice is then expected BEFORE the order is shipped. The Accounting Manager based upon the customer's credit history will determine terms for subsequent orders.

**CUSTOMER ORDER DEPOSITS:** A 50% deposit may be required for any order for non-standard or custom product. Any such deposit shall accompany Customer's purchase order.

**CREDIT POLICY:** Credit limits for all Customers will be determined by the Accounting Department. Any Customer submitting orders that exceed their credit limit will be required to make payment of a deposit for said orders or previously entered orders before those orders are entered into the production schedule. Customers will be notified that they have exceeded their credit limit by the Accounting Department.

**PAST DUE ACCOUNT STATUS:** Any Customer account that becomes past due will be placed on credit hold and no orders will be fulfilled or entered until the account is brought current. Any account that becomes more than 15 days past due will be referred to a collection agency for resolution and the customer will remain on credit hold until the entire balance due is paid in full. Any customer who is placed with a collection agency will be placed on Cash in Advance terms for a period of no less than one year, at which time the account will be reviewed and considered for alternate payment terms.

**COLLECTION COSTS:** In the event the Customer defaults on payment obligations to Invincible™, and Invincible™ must employ the services of an attorney or collection agency to enforce these obligations, Customer shall reimburse Invincible™ for all of its actual collection costs and expenses (including actual attorney's fees and court costs) upon demand.

**CHARGE BACKS:** Must be approved in writing and in advance by authorized Invincible™ agent. No approval, NO CHARGE BACK. Customers are responsible for contacting their sales representative with any concerns that may cause a charge back to be considered.

**REQUESTS FOR SPECIFIC DELIVERY TIME(S):** Invincible™ will consider requests for delivery times and for drop shipments to job sites, and will undertake reasonable efforts to indicate any such request(s) to product carriers. Invincible™ may, in its sole discretion, extend to customers the option of a carrier guaranteed set delivery time at an additional cost to Customer. Invincible™'s liability for any damages incurred for any late deliveries including labor and other expenses resulting from any such delays shall be limited to a refund of the charge for the aforementioned guaranteed set delivery time.

**ACCESSORIAL FEES:** Customers shall be responsible for the payment of any and all accessorial fees.

**STORAGE OF PRODUCT:** If following Invincible™'s acknowledgement of Customer's purchase order, Customer requests a delay in shipment for any period greater than one (1) day from the scheduled ship date, Customer shall be responsible for the payment of the following storage fees:

- 1.) Less than full trailer (11 pallets or 24 feet or less) \$5 per pallet.
- 2.) Full trailer - \$75 per day per trailer

**FUEL SURCHARGE FEE:** Invincible™ may impose a surcharge over time due to prevailing economic conditions.

## TITLE, RISK OF LOSS & DAMAGE OR SHORTAGE CLAIMS

**TITLE & RISK OF LOSS:** Title to products shall pass to Customer upon delivery by Invincible™ to the carrier. For purposes of risk or loss, all shipments are "FOB Origin" and Customer acknowledges that once Invincible™ delivers the product to the carrier, risk of loss shall pass to the Customer. If you receive product that is freight damaged, the following steps MUST BE TAKEN:

- 1.) Before signing for the merchandise, make careful notation of all damages on the bill of lading, delivery receipt &/or freight bill.
- 2.) Immediately file a claim with the delivery driver. Call our shipping department with claim number.
- 3.) This claim must be filed within five (5) days of delivery.
- 4.) Retain all shipping cartons for inspection by the carrier agent.  
For concealed damage, follow steps 2 through 4.

**SHIPMENT DAMAGE CLAIMS:** All products are packaged to comply with carrier requirements and leave Invincible™'s facility in good condition. Customer shall be responsible to carefully inspect all product(s) upon delivery before acceptance. Any damage discovered upon delivery must be noted on the bill of lading. Notification of damage discovered after delivery must be given to Invincible™ within five (5) days immediately following delivery. All products must remain at delivery location and must retain all original packaging. Invincible™ shall not be liable for loss or damage to product that occurs in transit, and Customer's sole remedy for any such damages shall be to seek appropriate recourse against the carrier. Digital pictures of damaged goods are required.

**SHORTAGE CLAIMS:** Customer must report shortage claims to Invincible™ within five (5) days immediately following delivery. Shortages reported after will not be honored.

**RETURNS:** No return shipments will be accepted, nor will credit be allowed unless the return is approved and a Return Merchandise Authorization (RMA) Number is issued by Invincible™'s Customer Service. Requests to return product must be made within fifteen (15) days of receiving product, and the product must be returned within forty-five (45) days of issuance of the return authorization number. All returns must be shipped as originally packaged and in A-1 resalable condition. Return goods are subject to a 30% handling charge and any freight charges incurred. Custom product orders and special items (including special finishes) may not be returned.

# General Product & Order Information

**PRODUCT SIZES / VARIATIONS:** Dimensions listed in tabular columns are as follows: W=Width, D=Depth, and H=Height. These are nominal dimensions. If size is critical, please obtain written verification from the factory. Variations may occasionally occur in dimensions shown in this book.

**ORDERING:** A hard copy purchase order is required. Please fax, email or mail your order to:

**Invincible™ Office Furniture Solutions**  
PO Box 1117  
Manitowoc, WI 54221-1117  
Fax: 920.683.2970  
Email: Sales@InvincibleFurniture.com

To expedite entry of your order, verify your order is complete and accurate. Be certain to include all catalog numbers, options, quantities, and selected finishes. Include purchase order numbers, bill to and ship to addresses, contact name, and specific shipping dates required. Please include the ship to contact's telephone number.

Individual product questions may be addressed through order examples and specific product information listed on each page or by calling Customer Service at 877.682.4601.

**ACKNOWLEDGEMENTS, CHANGES & CANCELLATIONS:** All complete credit approved orders received will be acknowledged within 5 working days via email, fax or mail. Any orders received without complete correct information will NOT be entered until complete correct information is received in writing. Verbal is not acceptable. Information must be confirmed via hard copy. Lead times are determined upon order entry. Customers accept responsibility for correct order information and are required to inspect their acknowledgements carefully. All orders are subject to approval of factory. Additions to existing orders require a new purchase order and the existing order will receive a new lead time.

Orders may be cancelled, but are subject to processing and restocking charges. A charge of 10% of net amount will be assessed on any item cancelled after an order has been entered for production but has not been manufactured. There will be a 50% restocking charge applied to any cancelled or changed item after it has been manufactured. Orders for nonstandard and custom products may not be cancelled.

**FINISHES, CUSTOM PRODUCTS & SPECIALS:** For standard finishes (paint, laminates, edge trim and fabrics) please visit us online at [www.InvincibleFurniture.com](http://www.InvincibleFurniture.com). Tangible samples may be requested by contacting our Customer Service department by fax, phone or via the web.

For custom color finishes we ask that you send a color sample to us for matching. Due to varying paint formulations, aging, oxidation, and effect of light, special and standard finishes are not guaranteed to match new or existing furniture.

For Custom Products or special finishes, please consult with our Engineering Department for a written price quote. Custom finishes and products are subject to a 12-week lead time and may not be cancelled or returned. A signature will be required prior to release of order to our production facility.

## ADDITIONAL NOTES ON FINISHES:

- a) **CUSTOM PAINT &/or TEXTURE MATCHING:** Minimum custom paint / texture matching is 10 pieces. A \$400 net set up fee will be charged per order. Lead times of 6-8 weeks will apply for any order having these special requests. Matching discontinued paint shall be considered a custom paint request.
- b) **STANDARD LAMINATE:** A \$40 net upcharge per surface will be applied to all nonstandard premium laminates selected. This includes any Formica, Pionite, or Nevamar laminate chosen over the standard offerings, as well as Wilsonart Premium & HD Premium selections.
- c) **EDGE TREATMENT OPTIONS:** If T-mold is standard, PVC is optional for \$25 net upcharge per surface.
- d) **PVC EDGE OPTIONS:** Custom match edge options are available. Minimum of 5,000 linear feet required. If PVC is standard, T-Mold is optional for no additional upcharge.
- e) **FABRIC OPTIONS:** Custom fabrics are available. Please contact our Invincible™ Customer Service Department.

**LIMITED LIFETIME WARRANTY:** Invincible™ brand metal products are warranted to be free from defects in material and workmanship for the entire useful life of the product (generally accepted to be 25 years) as long as the original purchaser owns the product. This warranty does not cover normal wear and tear that is to be expected over the course of ownership.

This warranty is conditioned on proper care of the product, and use of the product being limited to normal commercial use in a climate controlled environment. Modification or attachments to the product not specifically approved in writing by Invincible™ will void the warranty. Products that were not installed, used or maintained in accordance with the product instructions and warnings will void the warranty, as will attempts to make repairs by, or on behalf of the end customer. (Warranty will not apply to products used for lease or rental purposes.)

Invincible™ requires written proof of purchase to validate product warranty, including but not limited to a copy of Invincible™'s original invoice, along with affirmation that the claimant is the original purchaser. If

Invincible™ determines that a product is covered by warranty, it is at the sole discretion of Invincible™ to repair, provide replacement parts or to replace the item with the same or a comparable product. In no event will Invincible™ be responsible for incidental or consequential damage, and under no circumstances shall Invincible™'s liability under this warranty exceed the original purchase price of the product.

**CODE RESTRICTIONS:** Invincible™ considers its products to be office furniture and subject to all applicable local fire, electrical and building codes. As local codes vary, the purchaser is responsible to notify Invincible™ of all local codes. The proper application and installation of products is the purchaser's responsibility.

Products not manufactured by Invincible™ are listed here with their respective manufacturer warranties:

Keyboard Trays (5 years)	Progressive Suspensions (Limited Lifetime)
Task Lights (3 years)	Crank Adjustable Table Bases (5 years)
CPU Holders (5 years)	(extend from 3 years by Invincible™)
Locks (25 years)	Electrical Pop-ups and wiring (1 year)
	Panel Fabric (manufacturer warranty)

# VISTA Modular Furniture



## GENERAL PRODUCT INFORMATION

**VISTA is a free standing modular desking system. Standard product features include:**

### Tables

- High pressure laminate tops have balanced construction and vinyl T-mold edge (standard) or Optional PVC edge.
- Legs are 2" thick, all steel construction with smooth, rounded edges and leveling glides. Leg options include C-Leg, Access Leg, Full End Panel, Shared C-Leg and Shared Access Leg. All legs are non-handed and include grommets for vertical and horizontal wire management.
- Modesty panels are all steel construction and are available in 3 heights – Full Height, 3/4 Height and Wall Access Height, and come standard with cable channel.
- All tables are cartoned and ship knocked down (K.D.).
- Two grommets per table is standard. Grommets located in alignment with legs.

### Overhead Storage

- Flipper door risers are available with steel fronts, fabric fronts or laminate fronts.
- Flipper door risers and bookshelf risers are available with open back or with steel back and fabric tackboard.
- Corner bookshelf riser is standard with steel back and fabric covered tackboard.
- Corner riser tower provides total access to desk top space and maximizes overhead storage capacity.
- Slatwall organizer rack may be mounted between riser uprights. Multiple accessories available for organizer rack.
- Overhead storage ships fully assembled.
- Locking Options available - may be keyed alike to other overhead storage units and to pedestals.

### Privacy Screens

- Laminate covered privacy screens are available in 2 styles and mount to table tops.
- Fabric covered privacy screens are tackable and mount to table back panels.
- Slatwall organizer rack may be mounted directly onto fabric covered privacy screens and risers. Multiple accessories available for organizer rack.

### Pedestals

- Pedestals are all steel construction with steel ball bearing progressive suspensions. Box drawers and file drawers have full extension.
- Box drawers are equipped with one adjustable divider per drawer. Additional dividers may be purchased.
- File drawers have high sides for hanging folders. Optional compressors are available with an upcharge.
- Mobile pedestals have concealed caster base.
- Locking Option available - may be keyed alike to other pedestals and to overhead storage units.

**\* To order Pedestals, Center Drawers, Keyboard Trays and other Accessories refer to pages 18 to 22.**

# VISTA Desk / Table Overview

**Back Panel Options:** H = 3/4 Height 21-1/2" Back Panel  
 X = Wall Access Open Frame Back Panel  
 F = Full Height Back Panel

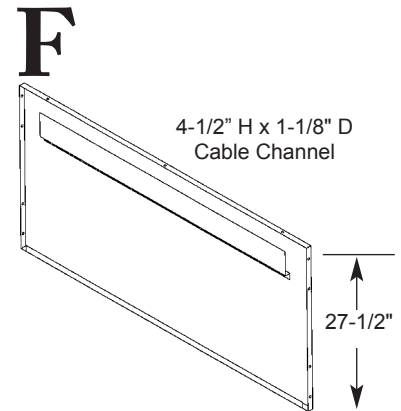
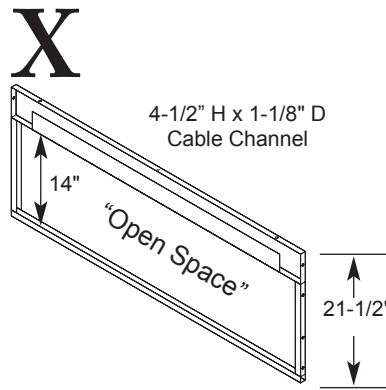
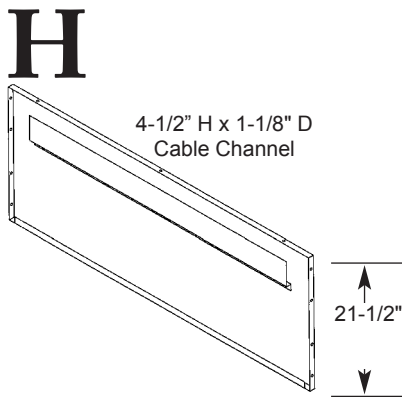

- Tables ship unassembled, knocked down (KD) and crated with tops, back panels and legs.
- All legs/end panels are 2" thick and are non-handed.
- Modesty panels come standard with cable channel.

**Note:** May not be used with power channels.

## Legs (Non-Handed)

- Maximum length of straight run tables with only clear access legs is 6'. Every 6' in a run should be supported by a C-Leg or an End Panel.
- Legs with hardware are approximately 5-1/2#.

C = C-Leg

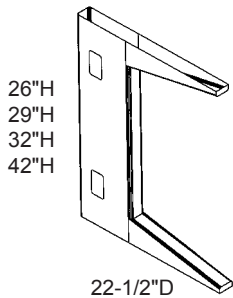

SCL = Shared C-Leg

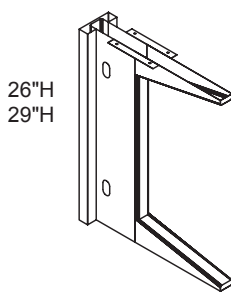

A = Access Leg

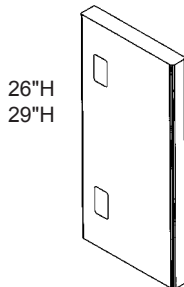

SAL = Shared Access Leg

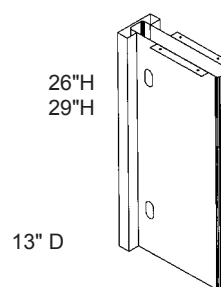

E or Q = Full End Panel

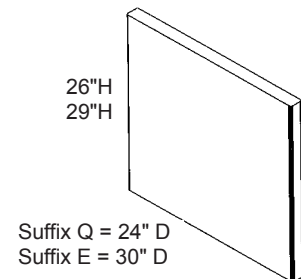

- 29H C-Leg may be ordered without grommet. Part number is C29NG. Call Customer Service at 877.682.4601 for current pricing.
- Inside of leg open (hollow) for vertical, concealed cable/cord passage
- Includes grommets for cable pass through
- Use shared leg when two adjacent tables are joined

- 29H Access Leg may be ordered without grommet. Part number is A29NG. Call Customer Service at 877.682.4601 for current pricing.
- Inside of leg open (hollow) for vertical, concealed cable/cord passage
- Includes grommets for cable pass through
- Use shared leg when two adjacent tables are joined

- Available as option to replace any C-Leg or Shared leg
- Primary use at end of run for full panel look or added support
- Tow hemmed oval openings for cord passage on inside only
- Only support style available for 36" deep tables
- Must be used on 30" deep tables if caster kit is ordered

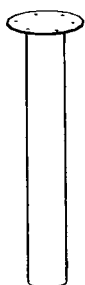

COL-SUP-29 Column

2 1/4" Dia.

Standard for D, C, F, P, half round convergent.

2

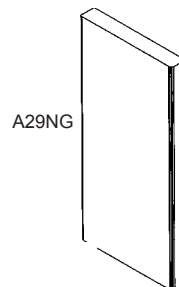

**NOTE:**

Access Legs are also available without grommets. Part number is A29NG.

# How to Order VISTA Modular Furniture

Standard rectangular VISTA tables do not have a prefix. Vista prefixes indicate: corner, type of corner, mobile or special height (if other than standard 29" high.)

**Example: SC30424230 # \*\*** (S=Standing Height 42"H, C=Corner, 3042230=30x42x42x3, suffix symbols stand for [#] back panel, and [\*] indicates type of leg)

- # the first suffix is back panels
- X = Wall Access No Upcharge
- H = 3/4 height (21-1/2") No Upcharge
- F = full to floor (27-1/2") Add \$50
- the second and third suffix are two leg options
- A = Access Leg
- C = C-Leg
- Q or E = End Panel
- N = No Leg

**NOTE:** Use the No Leg option when a table is being attached to a table with a shared leg. Subtract \$102.

- # For corner tables the first and second suffix are back panels.
- The third and fourth suffix are leg options

**Note:** Vinyl T-Mold edge is standard. PVC, Self Edge, and Waterfall edge treatments are available. Please consult factory. Legs are Non-handed.

**Example #1:** Freestanding **STANDARD HEIGHT** rectangular table, 42"H x 42"W x 30"D  
Full height modesty back panel, C-Leg on left, 30" deep end panel on right

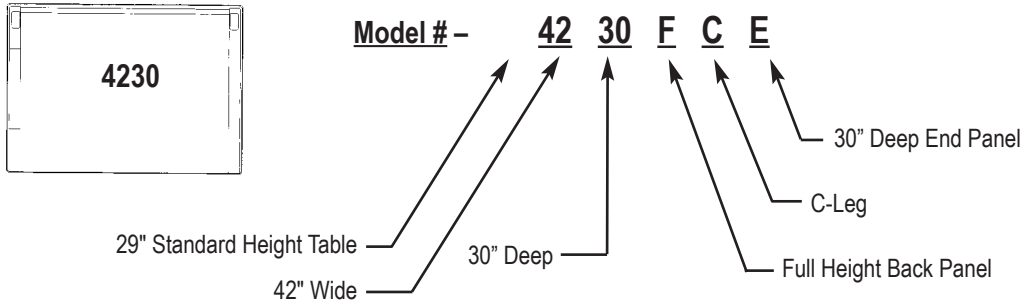

**Note:** Example #1 is a standard 29"H, is no prefix and appears as 4230FCE.

**Example #2:** Corner Table, 29"H x 36"W x 24"D, 3/4 height modesty back panels, no legs.

2 each 29"H x 60"W x 24"D rectangular tables, 3/4 height modesty back panel.  
Each table has 1 C-Leg, and 1 leg is omitted.  
2 shared access legs are used where corner table and rectangular tables meet and are ordered separately.

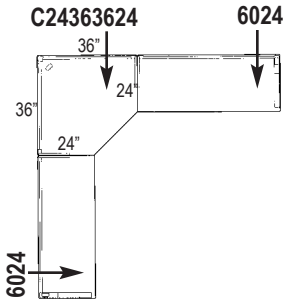

Four sets of dimensions called out left to right.

36"W (In this instance, both width dimensions are the same.)

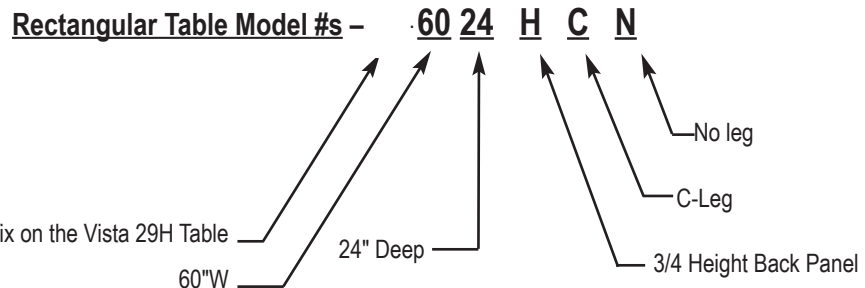
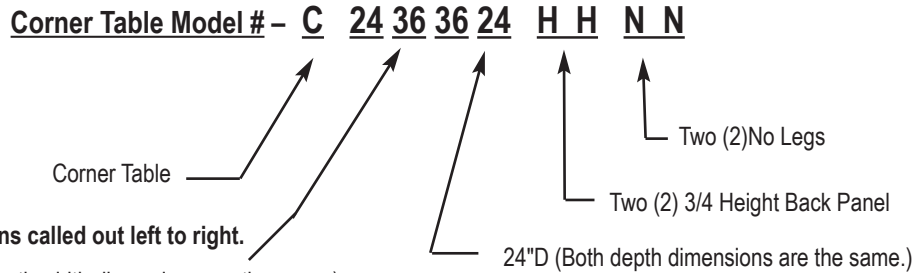

Please note that there is no prefix on the Vista 29H Table

**Specify paint, T-mold & laminate colors when ordering.**





# VISTA Desk / Table Overview

## Curved Top Tables Standard Height 29"

### Curved Top Tables

#### Back Panel Options Suffix= #

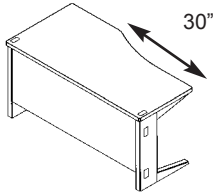

X = Wall Access  
H = 3/4 height (21-1/2")  
F = full to floor (27-1/2")

No Upcharge  
No Upcharge  
Add \$50

#### Leg Options Suffix= •

##### C-Leg (suffix C)

W	D	H	Catalog Number	List Price	Ship Weight
	L - R			T-Mold*	
36"	30-24"	29"	363024 #••-TE	\$895	108
48"	30-24"	29"	483024 #••-TE	\$895	110
54"	30-24"	29"	543024 #••-TE	\$984	118
60"	30-24"	29"	603024 #••-TE	\$1040	126
66"	30-24"	29"	663024 #••-TE	\$1098	130
72"	30-24"	29"	723024 #••-TE	\$1142	138

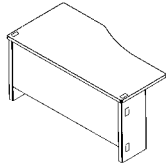

##### Access Leg (suffix A)

48"	24-30"	29"	482430 #••-TE	\$895	110
54"	24-30"	29"	542430 #••-TE	\$984	118
60"	24-30"	29"	602430 #••-TE	\$1040	126
66"	24-30"	29"	662430 #••-TE	\$1098	130
72"	24-30"	29"	722430 #••-TE	\$1142	138

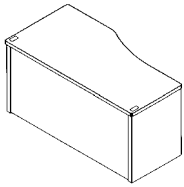

##### Full end panel (suffix Q = 24"D) (suffix E = 30"D)

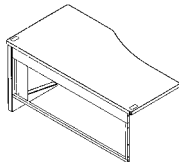

##### No leg (suffix N subtract \$80)

\* All line drawings represent "2430" tables to show all leg options.

### 5-Sided Curved Front Corner Tables

D W W D H

Front Radius

T-Mold\*

For back panel options  
See Above

For leg options  
See Above

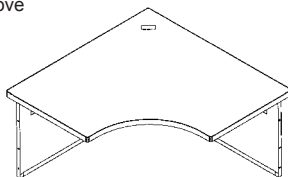

"No LEG" OPTION SHOWN

24"	36"	36"	24"	29"	12" radius	CC24363624 #•••-TE	\$1174	116
30"	42"	42"	30"	29"	12" radius	CC30424230 #•••-TE	\$1219	116
24"	42"	42"	24"	29"	18" radius	CC24424224 #•••-TE	\$1219	104
24"	42"	42"	30"	29"	12" radius	CC24424230 #•••-TE	\$1219	114
30"	42"	42"	24"	29"	12" radius	CC30424224 #•••-TE	\$1219	112
30"	48"	48"	30"	29"	18" radius	CC30484830 #•••-TE	\$1265	140



# VISTA Desk / Table Overview

## Rectangular Tables Wheelchair Access Height 32"

	W	D	H	Catalog Number	List Price	Ship Weight
<b>Rectangular ( C-Leg Only )</b>	<b>24" deep</b>			<b>T-Mold*</b>		
<b>Back Panel Options</b> <b>Suffix= #</b>  Suffix-H 3/4 Height 21-1/2" High Back Panel (No Upcharge)	24"	24"	32"	A2424 # CC-TE	\$730	62
	30"	24"	32"	A3024 # CC -TE	\$734	70
	36"	24"	32"	A3624 # CC-TE	\$754	76
	42"	24"	32"	A4224 # CC-TE	\$824	82
	48"	24"	32"	A4824 # CC-TE	\$858	88
	54"	24"	32"	A5424 # CC-TE	\$948	96
	60"	24"	32"	A6024 # CC-TE	\$1014	104
	66"	24"	32"	A6624 # CC-TE	\$1069	112
	72"	24"	32"	A7224 # CC-TE	\$1137	118

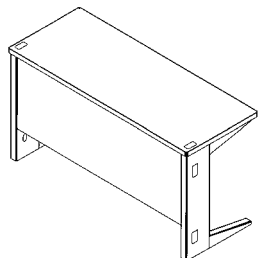

	W	D	H	Catalog Number	List Price	Ship Weight
	<b>30" deep</b>			<b>T-Mold*</b>		
Suffix-X Wall Access 21-1/2" High Back Panel (no upcharge)	24"	30"	32"	A2430 # CC-TE	\$771	70
	30"	30"	32"	A3030 # CC-TE	\$776	86
	36"	30"	32"	A3630 # CC-TE	\$805	94
	42"	30"	32"	A4230 # CC-TE	\$861	102
	48"	30"	32"	A4830 # CC-TE	\$924	110
	54"	30"	32"	A5430 # CC-TE	\$1014	118
	60"	30"	32"	A6030 # CC-TE	\$1069	126
	66"	30"	32"	A6630 # CC-TE	\$1137	132
	72"	30"	32"	A7230 # CC-TE	\$1197	138

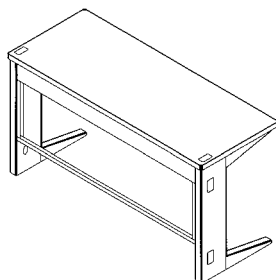

	D	W	W	D	H	Front Diagonal	T-Mold*
<b>5-Side Corner ( C-Leg Only )</b>							
For back panel options See Above	24"	36"	36"	24"	32"	16-1/2"	AC24363624 ## CC-TE \$1180 106
	30"	42"	42"	30"	32"	17"	AC30424230 ## CC-TE \$1253 122
	24"	42"	42"	24"	32"	25-1/2"	AC24424224 ## CC-TE \$1253 110
	24"	42"	42"	30"	32"	21-1/2"	AC24424230 ## CC-TE \$1253 118
	30"	42"	42"	24"	32"	21-1/2"	AC30424224 ## CC-TE \$1253 130
	30"	48"	48"	30"	32"	25-1/2"	AC30484830 ## CC-TE \$1310 146
	2"	13"	32"				Shared Access Leg SAL32 \$273 8
2"	22-1/2"	32"				Shared C-Leg SCL32 \$273 8	
2"	22-1/2"	32"				Non-Handed C-Leg C32 \$273 8	

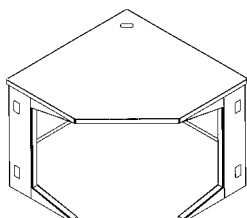

# VISTA Desk / Table Overview

## Rectangular Tables Standing Height 42"

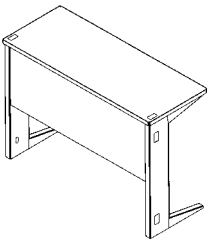
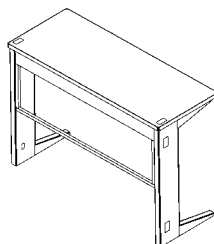
Rectangular ( C-Leg Only )			W	D	H	Catalog Number	List Price	Ship Weight
			<b>24" deep</b>			<b>T-Mold*</b>		
<b>Back Panel Options</b> Suffix= #		24"	24"	42"	S2424 # CC-TE	\$737	73	
		30"	24"	42"	S3024 # CC-TE	\$745	80	
		36"	24"	42"	S3624 # CC-TE	\$769	86	
		42"	24"	42"	S4224 # CC-TE	\$831	92	
		48"	24"	42"	S4824 # CC-TE	\$893	98	
		54"	24"	42"	S5424 # CC-TE	\$955	106	
		60"	24"	42"	S6024 # CC-TE	\$1016	114	
		66"	24"	42"	S6624 # CC-TE	\$1078	122	
		72"	24"	42"	S7224 # CC-TE	\$1142	128	
			<b>30" deep</b>			<b>T-Mold*</b>		
Suffix-H 3/4 Height 21-1/2" High Back Panel (No Upcharge)		24"	30"	42"	S2430 # CC-TE	\$783	89	
		30"	30"	42"	S3030 # CC-TE	\$788	96	
		36"	30"	42"	S3630 # CC-TE	\$815	104	
		42"	30"	42"	S4230 # CC-TE	\$873	112	
		48"	30"	42"	S4830 # CC-TE	\$935	120	
		54"	30"	42"	S5430 # CC-TE	\$1023	128	
		60"	30"	42"	S6030 # CC-TE	\$1081	136	
		66"	30"	42"	S6630 # CC-TE	\$1144	142	
		72"	30"	42"	S7230 # CC-TE	\$1202	148	
			<b>36" deep</b>			<b>T-Mold*</b>		
		72"	36"	42"	S7236 # CC-TE	\$1236	148	

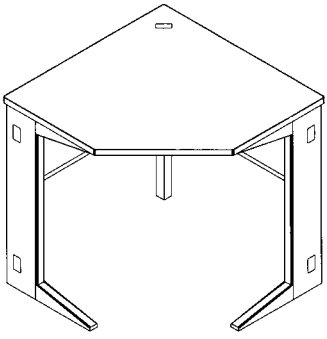
5-Side Corner ( C-Leg Only )			D	W	W	D	H	Front Diagonal	T-Mold*
For back panel options See Above		24"	36"	36"	24"	42"	16-1/2"	SC24363624 ## CC-TE	\$1190 116
		30"	42"	42"	30"	42"	17"	SC30424230 ## CC-TE	\$1255 132
		24"	42"	42"	24"	42"	25-1/2"	SC24424224 ## CC-TE	\$1255 120
		24"	42"	42"	30"	42"	21-1/2"	SC24424230 ## CC-TE	\$1255 120
		30"	42"	42"	24"	42"	21-1/2"	SC30424224 ## CC-TE	\$1255 120
		30"	48"	48"	30"	42"	25-1/2"	SC30484830 ## CC-TE	\$1316 156
		2"	13"	42"					Shared Access Leg SAL42
2"	22-1/2"	42"					Shared C-Leg SCL42	\$273 8	

# VISTA Peninsula Curved Inside Corner

Curved Peninsula Tables (T-edge Trim)

L W D H Catalog Number List Price Ship Weight

**Back Panel Options**  
Suffix= #

X = Wall Access  
H = 3/4 height (21-1/2")  
F = full to floor (27-1/2")

No Upcharge  
No Upcharge  
Add \$50

**Leg Options**  
Suffix= •

C= C-Leg  
Q = 24" deep end panel  
E = 30" deep end panel  
N = No Leg (Subtract \$80)  
A = Access Leg

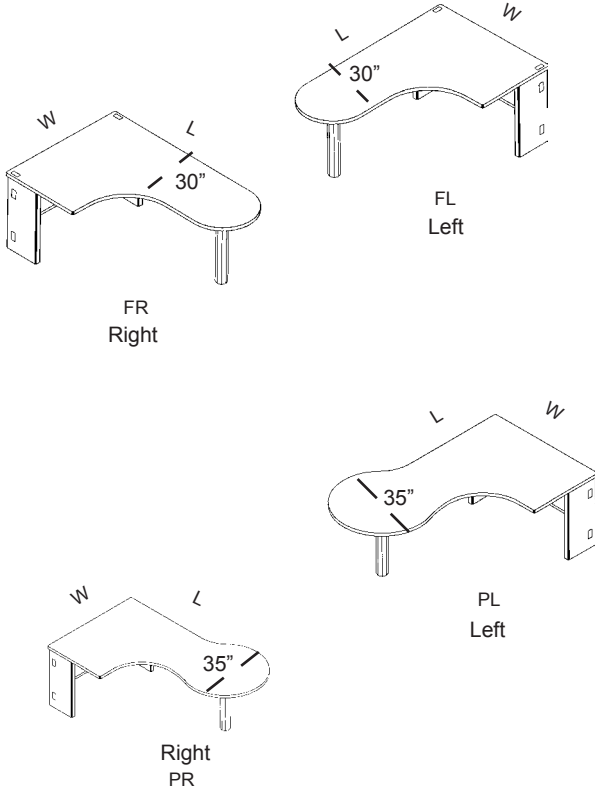

**"F" Freestanding**

**T-Mold\***

60"	42"	24"	29"	PF*604224 #••-TE	\$1135	103
72"	42"	24"	29"	PF*724224 #••-TE	\$1204	110
80"	42"	24"	29"	PF*804224 #••-TE	\$1250	117
60"	42"	30"	29"	PF*604230 #••-TE	\$1135	103
72"	42"	30"	29"	PF*724230 #••-TE	\$1204	110
80"	42"	30"	29"	PF*804230 #••-TE	\$1250	117
60"	48"	24"	29"	PF*604824 #••-TE	\$1135	103
72"	48"	24"	29"	PF*724824 #••-TE	\$1204	110
80"	48"	24"	29"	PF*804824 #••-TE	\$1250	117
60"	48"	30"	29"	PF*604830 #••-TE	\$1135	103
72"	48"	30"	29"	PF*724830 #••-TE	\$1204	110
80"	48"	30"	29"	PF*804830 #••-TE	\$1250	117
80"	60"	30"	29"	PF*806030#••-TE	\$1662	132

**"P" Freestanding**

**T-Mold\***

60"	48"	24"	29"	PP*604824 #••-TE	\$1131	103
72"	48"	24"	29"	PP*724824 #••-TE	\$1202	110
80"	48"	24"	29"	PP*804824 #••-TE	\$1250	117
60"	48"	30"	29"	PP*604830 #••-TE	\$1131	103
72"	48"	30"	29"	PP*724830 #••-TE	\$1202	110
80"	48"	30"	29"	PP*804830 #••-TE	\$1250	117
72"	42"	36"	29"	PP*724236 #••-TE	\$1261	128

**PLEASE SPECIFY:**

- \* specify L or R for Left or Right
- # specify back panel type
- specify leg choice

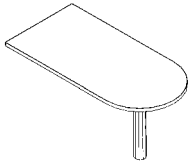
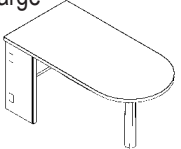
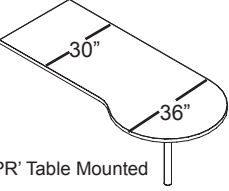
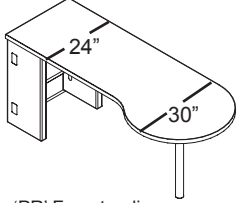
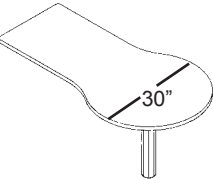
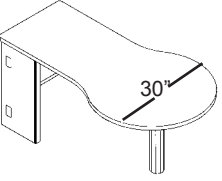

Paint Color  
Laminate Choice  
Edge Treatment [if other than standard treatment desired]

# VISTA Peninsula Tables Standard Height 29"

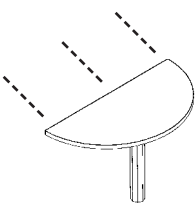
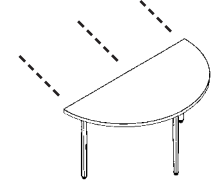
			W	D	H	Catalog Number	List Price	Ship Weight												
<b>"D", "P" &amp; "C" Peninsula</b>						<b>T-Mold*</b>														
<b>Back Panel Options</b> Suffix= #		<b>Leg Options</b> Suffix= •		^ = 'D' 'PL' or 'PR' Table Mounted																
X = Wall Access H = 3/4 height (21-1/2") F = full to floor (27-1/2")		C = C-Leg Q = 24" deep end panel E = 30" deep end panel N = No Leg (Subtract \$80) A = Access Leg																		
No Upcharge		No Upcharge																		
Add \$50		Add \$50																		
																				
'D' Table Mounted		'D' Freestanding																		
																				
'PR' Table Mounted		'PR' Freestanding																		
																				
'C' Table Mounted		'C' Freestanding																		
			48"			24"			29"			P^4824-TE			\$822			44		
			54"			24"			29"			P^5424-TE			\$861			52		
			60"			24"			29"			P^6024-TE			\$895			56		
			66"			24"			29"			P^6624-TE			\$984			66		
			72"			24"			29"			P^7224-TE			\$1054			73		
			48"			30"			29"			P^4830-TE			\$839			50		
			54"			30"			29"			P^5430-TE			\$887			58		
			60"			30"			29"			P^6030-TE			\$924			62		
			66"			30"			29"			P^6630-TE			\$1011			72		
			72"			30"			29"			P^7230-TE			\$1078			80		
			60"			24"			29"			P^6024 # • • -TE			\$1294			95		
			66"			24"			29"			P^6624 # • • -TE			\$1316			95		
			72"			24"			29"			P^7224 # • • -TE			\$1340			104		
			84"			24"			29"			P^8424 # • • -TE			\$1435			110		
			60"			30			29"			P^6030 # • • -TE			\$1316			91		
			66"			30			29"			P^6630 # • • -TE			\$1356			99		
			72"			30			29"			P^7230 # • • -TE			\$1404			107		
			84"			30			29"			P^8430 # • • -TE			\$1451			130		
<b>'C' Table Mounted (24" deep)</b>																				
			66"			24"			29"			PC6624-TE			\$1054			71		
			72"			24"			29"			PC7224-TE			\$1093			80		
<b>'C' Freestanding (24" deep)</b>																				
			66"			24"			29"			PC6624 # • • • -TE			\$1195			103		
			72"			24"			29"			PC7224 # • • • -TE			\$1217			112		

<b>Half Round Table</b>			<b>T-Mold*</b>																	
			<b>Fixed Half Round</b>																	
			30"dia			15"			29"			HR30-TE			\$824			22		
			48"dia			24"			29"			HR48-TE			\$904			40		
			60"dia			30"			29"			HR60-TE			\$1038			54		
			<b>Mobile Half Round</b>																	
			<b>Fixed Half Round (Use with 2" screens)</b>																	
			32"dia			16"			29"			HR32-TE			\$834			25		
			50"dia			25"			29"			HR50-TE			\$919			44		
			62"dia			31"			29"			HR62-TE			\$1052			56		
			<b>Mobile Half Round</b>																	
			30"dia			15"			29"			HRM30-TE			\$987			65		
			48"dia			24"			29"			HRM48-TE			\$1054			86		
			60"dia			30"			29"			HRM60-TE			\$1200			96		
			<b>Mobile Half Round (Use with 2" screens)</b>																	
			32"dia			16"			29"			HRM32-TE			\$996			68		
			50"dia			25"			29"			HRM50-TE			\$1067			89		
			62"dia			31"			29"			HRM62-TE			\$1209			99		

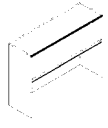
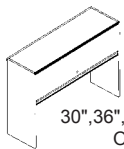
# VISTA Overhead Storage (Locks Included)

	W	D	H	Catalog Number	List Price	Ship Weight	Catalog Number	List Price	Ship Weight
<b>Risers- Steel fronts</b>	<b>(Open Back)</b>			<b>(W/Steel Back &amp; Tackboard)</b>					
	<b>paint only, no fabric</b>			<b>paint &amp; fabric</b>					
	30"	15"	35-1/2"	RDOR30LK	\$1078	62	RDBR30LK	\$1318	67
	36"	15"	35-1/2"	RDOR36LK	\$1098	70	RDBR36LK	\$1323	77
	42"	15"	35-1/2"	RDOR42LK	\$1113	78	RDBR42LK	\$1328	87
	48"	15"	35-1/2"	RDOR48LK	\$1131	86	RDBR48LK	\$1389	96
	54"	15"	35-1/2"	RDOR54LK	\$1166	94	RDBR54LK	\$1502	106
	60"	15"	35-1/2"	RDOR60LK	\$1217	102	RDBR60LK	\$1608	116
	66"	15"	35-1/2"	RDOR66LK	\$1374	108	RDBR66LK	\$1714	123
	72"	15"	35-1/2"	RDOR72LK	\$1425	114	RDBR72LK	\$1768	132
	78"	15"	35-1/2"	RDOR78LK		120	RDBR78LK		138

30", 36", 42", 48", 54", 60" Open back

30", 36", 42", 48", 54", 60" w/Steel back & Tackboard\*

66", 72", 78" w/Steel back & Tackboard\*

RDU interior 14-1/16"D x 12"H . RDU cabinet has closed steel back. Doors recede into cabinet. Approximately 20" clearance from worksurface to underside of shelf. Includes pressure sensitive tape to attach table to RDU.

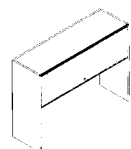
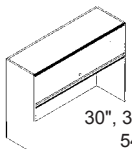
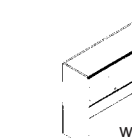
<b>Risers- Fabric fronts * Standard Invincible Fabric Offering</b>	W	D	H	Catalog Number	List Price	Ship Weight	Catalog Number	List Price	Ship Weight
	30"	15"	35-1/2"	RDOF30LK	\$1098	62	RDBF30LK	\$1333	67
	36"	15"	35-1/2"	RDOF36LK	\$1113	70	RDBF36LK	\$1338	77
	42"	15"	35-1/2"	RDOF42LK	\$1131	78	RDBF42LK	\$1345	87
	48"	15"	35-1/2"	RDOF48LK	\$1149	86	RDBF48LK	\$1405	96
	54"	15"	35-1/2"	RDOF54LK	\$1182	94	RDBF54LK	\$1517	106
	60"	15"	35-1/2"	RDOF60LK	\$1234	102	RDBF60LK	\$1616	116
	66"	15"	35-1/2"	RDOF66LK	\$1389	108	RDBF66LK	\$1720	123
	72"	15"	35-1/2"	RDOF72LK	\$1449	114	RDBF72LK	\$1790	132
	78"	15"	35-1/2"	RDOF78LK		120	RDBF78LK		138

30", 36", 42", 48", 54", 60" w/Steel back & Tackboard\*

30", 36", 42", 48", 54", 60" Open Back

66", 72", 78" w/Steel back & Tackboard\*

RDU interior 14-1/16"D x 12"H . RDU cabinet has closed steel back. Doors recede into cabinet. Approximately 20" clearance from worksurface to underside of shelf. Includes pressure sensitive tape to attach table to RDU.

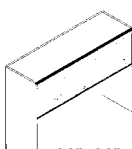
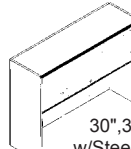
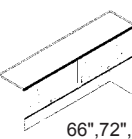
<b>Risers- * Laminate on Steel Core (Horizontal Grain Direction)</b>	W	D	H	Catalog Number	List Price	Ship Weight	Catalog Number	List Price	Ship Weight
	30"	15"	35-1/2"	RDOL30LK	\$1131	62	RDBL30LK	\$1367	67
	36"	15"	35-1/2"	RDOL36LK	\$1149	70	RDBL36LK	\$1371	77
	42"	15"	35-1/2"	RDOL42LK	\$1186	78	RDBL42LK	\$1400	87
	48"	15"	35-1/2"	RDOL48LK	\$1206	86	RDBL48LK	\$1425	96
	54"	15"	35-1/2"	RDOL54LK	\$1253	94	RDBL54LK	\$1466	106
	60"	15"	35-1/2"	RDOL60LK	\$1323	102	RDBL60LK	\$1700	116
	66"	15"	35-1/2"	RDOL66LK	\$1502	108	RDBL66LK	\$1822	123
	72"	15"	35-1/2"	RDOL72LK	\$1618	114	RDBL72LK	\$1959	132
	78"	15"	35-1/2"	RDOL78LK		120	RDBL78LK		138

30", 36", 42", 48", 54", 60" w/Steel back & Tackboard\*

30", 36", 42", 48", 54", 60" Open Back

66", 72", 78" w/Steel back & Tackboard\*

RDU interior 14-1/16"D x 12"H . RDU cabinet has closed steel back. Doors recede into cabinet. Approximately 20" clearance from worksurface to underside of shelf. Includes pressure sensitive tape to attach table to RDU.

**NOTE:** Pull hardware not included.  
 Optional pulls dependent upon type of riser.  
 Please consult Customer Service at 1-877-682-4601 for additional information.

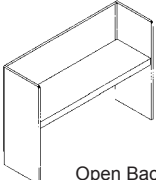
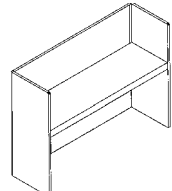
<b>Bookshelf</b>	W	D	H	Catalog Number	List Price	Ship Weight	Catalog Number	List Price	Ship Weight
	30"	15"	35-1/2"	RSOR30	\$590	59	RSBR30	\$889	59
	36"	15"	35-1/2"	RSOR36	\$612	60	RSBR36	\$901	65
	42"	15"	35-1/2"	RSOR42	\$624	61	RSBR42	\$912	71
	48"	15"	35-1/2"	RSOR48	\$635	70	RSBR48	\$935	80
	54"	15"	35-1/2"	RSOR54	\$650	80	RSBR54	\$981	95
	60"	15"	35-1/2"	RSOR60	\$663	90	RSBR60	\$996	104
	66"	15"	35-1/2"	RSOR66	\$694	101	RSBR66	\$1056	115
	72"	15"	35-1/2"	RSOR72	\$714	110	RSBR72	\$1081	126
	78"	15"	35-1/2"	RSOR78		113	RSBR78		129

Open Back

Steel back and Tackboard\*

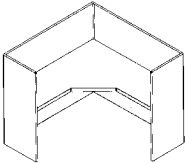

# VISTA Overhead Storage (Locks Included)

	W	D	H	Catalog Number	List Price	Ship Weight	Catalog Number	List Price	Ship Weight
				(Steel Back)			(W/Steel Back & Tackboard*)		
<b>Corner Bookshelf</b>									
	36"/36"	15"	35-1/2"	RSCR36	\$1206	95	RSCBR36	\$1458	99
	42"/42"	15"	35-1/2"	RSCR42	\$1253	105	RSCBR42	\$1490	108
	48"/48"	15"	35-1/2"	RSCR48	\$1279	120	RSCBR48	\$1541	125

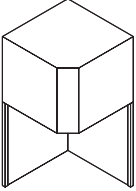
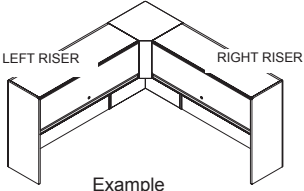
<b>Riser Tower</b>									
		24"	24"	35-1/2"	RT24	\$439	73		
<p>*Corner tower is used with risers listed below to form corner storage units.                      *Requires paint &amp; fabric*</p>									

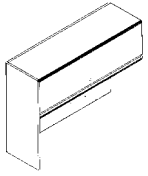
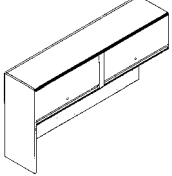
<b>Risers- Steel Fronts, Steel Backs &amp; Tackboard*</b>				<b>Left</b>			<b>Right</b>			
		36"	15"	35-1/2"	LRS36LK	\$1253	70	RRS36LK	\$1253	78
		42"	15"	35-1/2"	LRS42LK	\$1257	78	RRS42LK	\$1257	78
		48"	15"	35-1/2"	LRS48LK	\$1323	86	RRS48LK	\$1323	86
		54"	15"	35-1/2"	LRS54LK	\$1427	94	RRS54LK	\$1427	94
		60"	15"	35-1/2"	LRS60LK	\$1546	102	RRS60LK	\$1546	102
		66"	15"	35-1/2"	LRS66LK	\$1623	108	RRS66LK	\$1623	108
		72"	15"	35-1/2"	LRS72LK	\$1700	114	RRS72LK	\$1700	114
		78"	15"	35-1/2"	LRS78LK		120	RRS78LK		120
36", 42", 48", 54", 60"		66", 72", 78"								
<b>(Must be used with Riser Tower)</b>				RDU interior 14-1/16"D x 12"H . RDU cabinet has closed steel back. Doors recede into cabinet. Approximately 20" clearance from worksurface to underside of shelf. Includes pressure sensitive tape to attach table to RDU.						

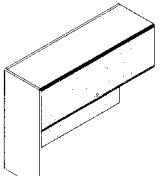
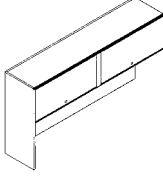
<b>Risers – Fabric Fronts / Steelback &amp; Tackboard</b>				<b>Left</b>			<b>Right</b>			
		36"	15"	35-1/2"	LRF36LK	\$1270	70	RRF36LK	\$1270	78
		42"	15"	35-1/2"	LRF42LK	\$1279	78	RRF42LK	\$1279	78
		48"	15"	35-1/2"	LRF48LK	\$1338	86	RRF48LK	\$1338	86
		54"	15"	35-1/2"	LRF54LK	\$1463	94	RRF54LK	\$1463	94
		60"	15"	35-1/2"	LRF60LK	\$1580	102	RRF60LK	\$1580	102
		66"	15"	35-1/2"	LRF66LK	\$1667	108	RRF66LK	\$1667	108
		72"	15"	35-1/2"	LRF72LK	\$1720	114	RRF72LK	\$1720	114
		78"	15"	35-1/2"	LRF78LK		120	RRF78LK		120
36", 42", 48", 54", 60"		66", 72", 78"								
<b>(Must be used with Riser Tower)</b>				RDU interior 14-1/16"D x 12"H . RDU cabinet has closed steel back. Doors recede into cabinet. Approximately 20" clearance from worksurface to underside of shelf. Includes pressure sensitive tape to attach table to RDU.						

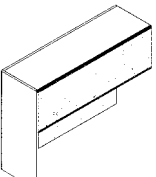
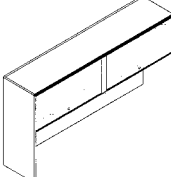
<b>Risers– Laminate Front With Steel Back &amp; Tackboard (Horizontal Grain Direction)</b>				<b>Left</b>			<b>Right</b>			
		36"	15"	35-1/2"	LRL36LK	\$1303	70	RRL36LK	\$1303	78
		42"	15"	35-1/2"	LRL42LK	\$1328	78	RRL42LK	\$1328	78
		48"	15"	35-1/2"	LRL48LK	\$1396	86	RRL48LK	\$1396	86
		54"	15"	35-1/2"	LRL54LK	\$1517	94	RRL54LK	\$1517	94
		60"	15"	35-1/2"	LRL60LK	\$1636	102	RRL60LK	\$1636	102
		66"	15"	35-1/2"	LRL66LK	\$1760	108	RRL66LK	\$1760	108
		72"	15"	35-1/2"	LRL72LK	\$1892	114	RRL72LK	\$1892	114
		78"	15"	35-1/2"	LRL78LK		120	RRL78LK		120
36", 42", 48", 54", 60"		66", 72", 78"								
<b>(Must be used with Riser Tower)</b>				RDU interior 14-1/16"D x 12"H . RDU cabinet has closed steel back. Doors recede into cabinet. Approximately 20" clearance from worksurface to underside of shelf. Includes pressure sensitive tape to attach table to RDU.						

# VISTA Laminated Privacy Screens

	W	D	H	Catalog Number	List Price	Ship Weight
--	---	---	---	----------------	------------	-------------

## Table Mount – 3/4" Laminated Privacy Screen

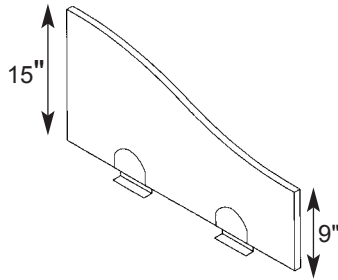

24"	3/4"	9" / 15"	CLP24-SE	\$167	8
30"	3/4"	9" / 15"	CLP30-SE	\$181	9
36"	3/4"	9" / 15"	CLP36-SE	\$187	10
42"	3/4"	9" / 15"	CLP42-SE	\$197	11
48"	3/4"	9" / 15"	CLP48-SE	\$202	12
54"	3/4"	9" / 15"	CLP54-SE	\$213	13
60"	3/4"	9" / 15"	CLP60-SE	\$220	14
66"	3/4"	9" / 15"	CLP66-SE	\$229	15
72"	3/4"	9" / 15"	CLP72-SE	\$241	16

Laminate privacy screens are made to set on top of VISTA top and attach to the underside of VISTA top with brackets.

Two VS-10-PNT screen brackets included with each screen.

Additional brackets may be purchased for \$15 each.

## Table Mount For Rectangular Table, 3/4" Laminated Privacy Screen

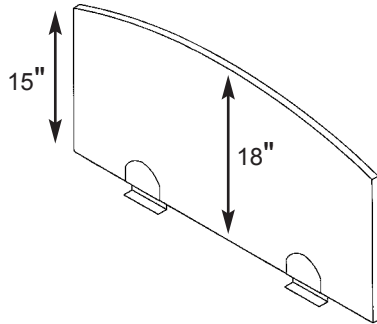

30"	3/4"	18"	VLP3015-SE	\$181	12
36"	3/4"	18"	VLP3615-SE	\$187	13
42"	3/4"	18"	VLP4215-SE	\$197	14
48"	3/4"	18"	VLP4815-SE	\$202	15
54"	3/4"	18"	VLP5415-SE	\$213	16
60"	3/4"	18"	VLP6015-SE	\$220	17
66"	3/4"	18"	VLP6615-SE	\$229	18
72"	3/4"	18"	VLP7215-SE	\$241	19

## Table Mount for Table Ends – 3/4" Laminated Privacy Screen

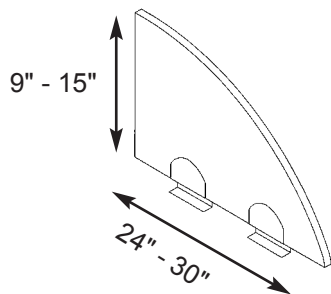

24"	3/4"	9"	ELP2409-SE	\$167	8
24"	3/4"	15"	ELP2415-SE	\$181	11
30"	3/4"	9"	ELP3009-SE	\$181	9
30"	3/4"	15"	ELP3015-SE	\$187	12

Laminated wood core privacy screen with self-edge laminate. Two mounting brackets per screen are included.

Clear or satin etched glass privacy screens with polished edges available. Consult customer service for pricing.

# VISTA Privacy Wall Screens

## 2" Thick Fabric Covered with Steel Core

VISTA

	W	D	H	Catalog Number	List Price	Ship Weight	Catalog Number	List Price	Ship Weight
<b>Table Mount – 2" Thick</b>				(19" High)			(35' High)		

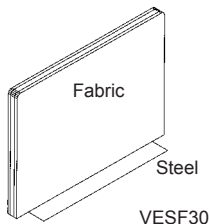
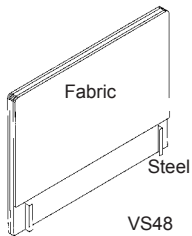

### For Rectangular & Corner Tables

24"	2"	19" or 35-1/2"	VS2419	\$619	17	VS2435	\$703	25
30"	2"	19" or 35-1/2"	VS3019	\$643	20	VS3035	\$725	28
36"	2"	19" or 35-1/2"	VS3619	\$650	24	VS3635	\$747	32
42"	2"	19" or 35-1/2"	VS4219	\$684	28	VS4235	\$781	36
48"	2"	19" or 35-1/2"	VS4819	\$721	32	VS4835	\$820	44
54"	2"	19" or 35-1/2"	VS5419	\$747	36	VS5435	\$851	52
60"	2"	19" or 35-1/2"	VS6019	\$778	40	VS6035	\$887	60
66"	2"	19" or 35-1/2"	VS6619	\$813	44	VS6635	\$921	68
72"	2"	19" or 35-1/2"	VS7219	\$846	48	VS7235	\$957	76

Note: Post is required when 90 degree connection is used.

### For 24" & 30" Deep Table Ends (Mounting Plate Included)

24"	2"	19" or 35-1/2"	VESF2419	\$628	18	VESF2435	\$699	26
30"	2"	19" or 35-1/2"	VESF3019	\$646	22	VESF3035	\$718	30

Note: Must specify VFC20EXT separately (table connecting plate) when using end screens between two tables. End screens are not designed to be used alone. End screens cannot stand-alone and must be used with back screen and corner post.

Please specify paint & fabric.

Paint is required for mounting brackets and frame.

### Privacy Screen Post

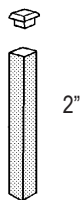

W	D	H	Catalog Number	Description	List Price	Ship Weight
2"	2"	19"	VJC19	Privacy Post	\$164	3
2"	2"	35-1/2"	VJC35	Privacy Post	\$176	5

Note: Fabric covered universal connecting post for 2" table screens. Use to join screens at 2-way, 3-way or 4-way intersections.

### Transaction Shelf

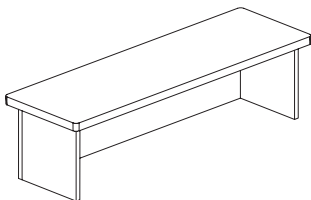

W	D	H	Catalog Number	Description	List Price	Ship Weight
36"	15"	13"	TS36-OS-TE	Steel front and back panels	\$701	29
42"	15"	13"	TS42-OS-TE	with Vinyl T-Mold edge on	\$728	34
48"	15"	13"	TS48-OS-TE	lamine transaction top.	\$776	39
54"	15"	13"	TS54-OS-TE		\$813	44
60"	15"	13"	TS60-OS-TE	PVC edge for transaction top	\$844	49
66"	15"	13"	TS66-OS-TE	available @ \$25 net up charge	\$873	54
72"	15"	13"	TS72-OS-TE	per surface.	\$912	59

No brackets required for Transaction Shelves.

Transaction Shelves may be ordered with Vinyl T-Mold edge (-TE suffix) or PVC edge (-PV suffix).

When ordering, please specify: paint, laminate, fabric (needed for tackboard) and edge treatment selection.

Fabric covered tackboard is adhered with the use of PSA (double-sided) tape.

# VISTA Workspace Organizers

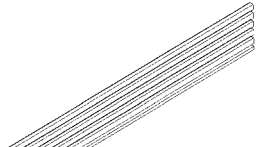
Slatwall – Organizer Rack	W	D	H	Catalog Number	List Price	Ship Weight
		36"	1-3/8"	5-1/2"	VSOR36	\$190
	42"	1-3/8"	5-1/2"	VSOR42	\$200	6
	48"	1-3/8"	5-1/2"	VSOR48	\$211	8
	54"	1-3/8"	5-1/2"	VSOR54	\$217	9
	60"	1-3/8"	5-1/2"	VSOR60	\$224	10

Note: Attaches with screws to 2" privacy screens. (screws included).  
5 horizontal rail opening allow accessory attachment.  
Available in Black only.

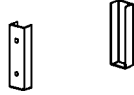







Riser Mount Clips

(Required to attach to riser uprites.)

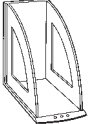
### Riser Mount Clips

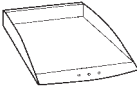
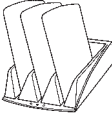
VORC \$77 1

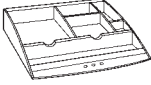
### Organizer Accessories for Slatwall (Plastic Components)

	4.75"	10.75"	8.75"	BBH	\$74	1
	8.5"	8.4"	2.0"	CDH	\$91	1
	7.25"	2.5"	12"	FFH	\$97	2
	4.9"	10.6"	8.8"	MTH	\$61	1
	4.9"	10.6"	8.8"	PPH	\$61	1
	8.6"	9.6"	1.85"	PSH	\$44	1
	9.3"	10.1"	1.9"	PTH	\$107	1
	24"	7"	1.75"	STH	\$101	2
			Replacement Mounting Hooks	HHH	\$10 Net each	

Note: Accessories are available in **Black** only. Mounting hooks are included.

# VISTA Table Accessories

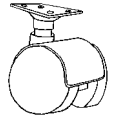
Connecting Plate/Caster Kit		W	D	H	Catalog Number	List Price	Ship Weight
	PPS-91-PLT	3-1/2"	1"		PPS-91-PLT	\$10	
		1-7/8"	2-1/4"	2-1/2"	V-CASTKIT	\$178	4
V-CASTKIT		Raises table height approximately 2-5/8" 2 casters locking and 2 non-locking All casters swivel					

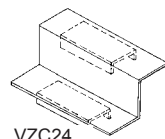
Offset / Dual Height Support Bracket					Catalog Number	List Price	Ship Weight
	VZC24	22-1/8" x 3" overall height. "Z" shape, 14 gauge.			VZC24	\$74	2
	(Specify Paint Finish)						

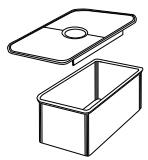

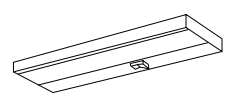
Grommets for Worksurfaces					Catalog Number	List Price	Ship Weight
	1-GRR	3"	1-1/2"	2	1-GRR	\$57	1
	Grommet for Worksurface - black only						

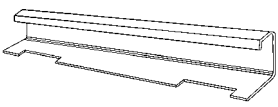
Task Light		Wide					
	Full Height Riser Task Light (Bookshelf or RDU) Provides energy efficient illumination.		Please refer to page 81 for available item sizes and pricing.				

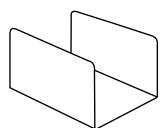
Task Light Cord Managers (Please specify fabric.)					Catalog Number	List Price	Ship Weight
		19"			VCM19	\$77	1

Storage Space Divider (Steel - Please specify paint finish.)		W	D	H	Catalog Number	List Price	Ship Weight
		9"	11-1/2"	7-1/2"	DIV9	\$58	5

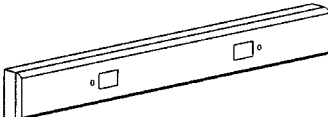
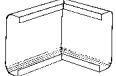
# VISTA Electrical

				Catalog Number	Notes	List Price
<b>Power Channel</b>				<b>(Electrified)</b>		
	<b>W</b>	<b>D</b>	<b>H</b>			
	24"	2"	6"	PC24A		\$441
	30"	2"	6"	PC30A		\$444
	36"	2"	6"	PC36A		\$449
	42"	2"	6"	PC42A		\$462
	48"	2"	6"	PC48A		\$471
	54"	2"	6"	PC54A		\$483
	60"	2"	6"	PC60A		\$496
	66"	2"	6"	PC66A		\$511
	72"	2"	6"	PC72A		\$531
				CFP		\$ 61
				EFP		\$ 35
				SFP		\$ 33

CFP = Corner Filler Plate  
EFP = End Filler Plate  
SFP = In-Line Filler Plate

**Note: Does not include ICA Interconnecting Cables. Must order Separately. See below.**

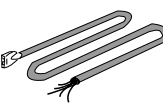
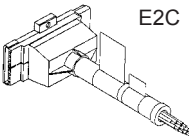
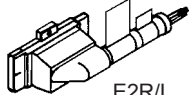
<b>Power Pole/Power Entry</b>						
						
						
	2"	2"	65"	VSPC65	Power Pole (paint) Includes VPAB Bracket	\$229
	2"	2"	81"	VSPC81	Power Pole (paint) Includes VPAB Bracket	\$194
				SCA18	18' Flex Conduit	\$241
				E2C	Base Power	\$230
				E2R	Base Power	\$230
				E2L	Base Power	\$230

**\*Power Pole does not include SCA-18: order separately**

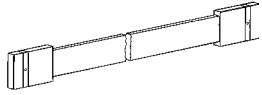
<b>Interconnecting Cable Access - Isolated Ground</b>						
	21-3/4"			ICA17	(straight to straight)	\$ 88
	24"			ICA19	(Corner Connection)	\$ 88

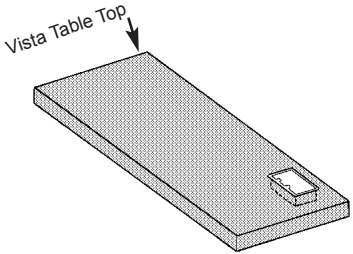
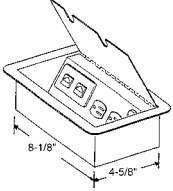
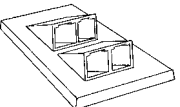
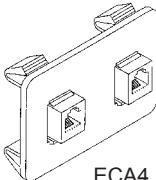
<b>Electronic Communications Access</b>						
						
	8-1/8"	4-5/8"	2	ECA2	Recessed Power Outlet	\$373
				ECA3	Desk top Comm. Port	\$184
				ECA4	Raceway Comm. Port	\$ 86

ECA2: Recessed power & telecommunication outlets. 15 amp / 125 volt duplex receptacle with voice/data plate includes RJ45 / RJ11 IDC connectors. Consult Factory for other data outlets. Units can be "daisy chained". Power cord is 6' long. Includes circuit breaker for overload protection. For factory cutout, specify location in desk top or worksurface. Ships separate from worksurface for field installation. Spring loaded, self-closing lid.

ECA3: Desk top communication port accepts up to 4 jacks (jacks included-specify type).

ECA4: Raceway communication port accepts up to 2 jacks (jacks included-specify type).

RJ45: Internet / RJ11: Phone

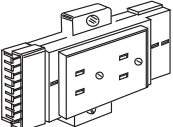
<b>Duplex Receptacles</b>						
						
				DR1	Utility Circuit	\$47 each
				DR2	Utility Circuit	\$47 each
				DR3	Utility Circuit	\$47 each
				IG4	Isolated Ground Circuit	\$47 each

Note: Circuits 1, 2 & 3 are available in Grey Putty or Black.

Note: IG4 available in Orange only.

# Pedestals & Accessories

---



## GENERAL PRODUCT INFORMATION

- Pedestals are available in 22-3/32" and 28-3/4" depths.
- With or without steel tops.
- Pedestal drawer options come in either B (Box/Box/File) or F (File/File) configuration.
- Four 1" leveling glides standard on each pedestal.
- Box drawers come standard with one divider.
- File drawers have full height sides for hanging folders.
- Full recessed pull along drawer front (Steel Fronts).
- Laminate drawer front with self edge is standard. PVC edge option is available with waterfall handle - for upcharge. Please consult factory.
- Box and file drawers have full progression ball bearing suspensions.
- Compressor option available.
- Pencil tray option available for box style drawers.
- Mobile pedestal option available in 22-3/32" and 28-3/4" depths.
- Cushion top mobile pedestal option available in 22-3/32" and 28-3/4" depths.
- Locks may be keyed alike to other pedestals, center drawers, verticals, laterals, etc. This must be specified at time of order.

**NOTE: Posting shelves may be added to 28-3/4 pedestals.  
Simply add "-PS" to suffix and add \$155 to list price.**

# Ultra Series Pedestals ... aka Ultrapedes

Pedestals & Accessories

22" Deep

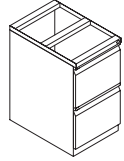

U2215F-LK

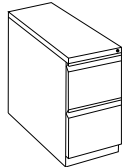

UT2215F-LK

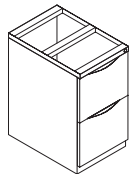

UL2215F-LK

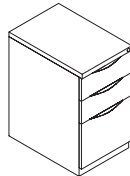

ULT2215B-LK

UTM2215B-LK

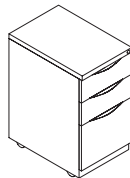

ULTM2215B-LK



W	D	H	Catalog Number	Notes	List Price	Ship Weight
---	---	---	----------------	-------	------------	-------------

**No Top - Steel Fronts**

15"	22-3/32"	27-3/4"	U2215B	Box/Box/File	\$612	68
			U2215B-LK	Box/Box/File w/lock	\$642	70
			U2215F	File/File	\$536	66
			U2215F-LK	File/File w/lock	\$568	68

**With Steel Top - Steel Fronts**

15"	22-3/32"	27-3/4"	UT2215B	Box/Box/File	\$649	70
			UT2215B-LK	Box/Box/File w/lock	\$677	72
			UT2215F	File/File	\$573	68
			UT2215F-LK	File/File w/lock	\$605	70

**Mobile Ped With Steel Top - Steel Fronts**

15"	22-3/32"	28"	UTM2215B-LK	Box/Box/File w/lock	\$804	77
			UTM2215F-LK	File/File w/lock	\$732	79

**No Top - Laminate Fronts (Vertical Grain Direction)**

15"	22-3/32"	27-3/4"	UL2215B	Box/Box/File	\$714	72
			UL2215B-LK	Box/Box/File w/lock	\$744	74
			UL2215F	File/File	\$624	70
			UL2215F-LK	File/File w/lock	\$651	72

\* Self Edge Standard

**With Steel Top - Laminate Fronts (Vertical Grain Direction)**

15"	22-3/32"	27-3/4"	ULT2215B	Box/Box/File	\$753	73
			ULT2215B-LK	Box/Box/File w/lock	\$781	75
			ULT2215F	File/File	\$658	71
			ULT2215F-LK	File/File w/lock	\$691	73

\* Self Edge Standard

**Mobil Ped With Steel Top - Laminate Fronts (Vertical Grain Direction)**

15"	22-3/32"	28"	ULTM2215B-LK	Box/Box/File w/lock	\$903	81
			ULTM2215F-LK	File/File w/lock	\$818	79

\* Self Edge Standard

**Note:** Box drawer includes one DIV15 divider. Additional DIV15 may be purchased. DIV15 measure 12-1/6W x 4H. Please refer to page 20 for purchasing information.

File drawers have full height sides for hanging folders. Compressors may be added at an upcharge if specified on order.

**Cushion top peds available in varying depths and heights.**

W	D	H				
---	---	---	--	--	--	--

**Mobil Ped With Steel Top with Cushion**

15"	22-3/32"	32"	UTMC2215B-LK	Box/Box/File w/lock	\$919	75
			UTMC2215F-LK	File/File w/lock	\$848	73
15"	28-3/4"	32"	UTMC2815B-LK	Box/Box/File w/lock	\$993	83
			UTMC2815F-LK	File/File w/lock	\$926	81
15"	22-3/32"	24"	UTMC2250BF-LK	Box/File w/lock	\$1038	55



# Ultra Series Pedestals ... aka Ultrapedes

Pedestals & Accessories

	W	D	H	Catalog Number	Notes	List Price	Ship Weight
--	---	---	---	----------------	-------	------------	-------------

## 22" Deep Suspended Pedestals

### Steel Fronts

15"	22-3/32"	19-61/64"	U2250BF	Box/File	\$594	53
			U2250BF-LK	Box/File w/lock	\$628	53

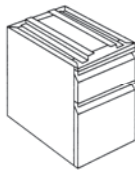

U2250BF

### Laminate Fronts (Vertical Grain Direction)

15"	22-3/32"	19-61/64"	UL2250BF	Box/File	\$663	58
			UL2250BF-LK	Box/File w/lock	\$704	58

## 28" Deep

### No Top - Steel Fronts

15"	28-3/4"	27-3/4"	U2815B	Box/Box/File	\$695	82
			U2815B-LK	Box/Box/File w/lock	\$728	82
			U2815F	File/File	\$624	80
			U2815F-LK	File/File w/lock	\$651	80

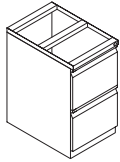

U2815F

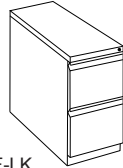

UT2815F-LK

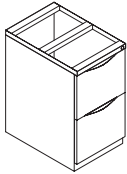

UL2815F

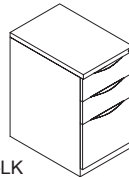

ULT2815B-LK

### With Steel Top - Steel Fronts

15"	28-3/4"	27-3/4"	UT2815B	Box/Box/File	\$734	84
			UT2815B-LK	Box/Box/File w/lock	\$767	84
			UT2815F	File/File	\$663	82
			UT2815F-LK	File/File w/lock	\$691	82

### Mobile Ped With Steel Top - Steel Fronts

15"	28-3/4"	28"	UTM2815B-LK	Box/Box/File w/lock	\$878	91
			UTM2815F-LK	File/File w/lock	\$811	91

### No Top - Laminate Fronts (Vertical Grain Direction)

15"	28-3/4"	27-3/4"	UL2815B	Box/Box/File	\$804	86
			UL2815B-LK	Box/Box/File w/lock	\$831	86
			UL2815F	File/File	\$725	84
			UL2815F-LK	File/File w/lock	\$755	84

\*Self Edge Standard

### With Steel Top - Laminate Fronts (Vertical Grain Direction)

15"	28-3/4"	27-3/4"	ULT2815B	Box/Box/File	\$811	87
			ULT2815B-LK	Box/Box/File w/lock	\$845	87
			ULT2815F	File/File	\$746	85
			ULT2815F-LK	File/File w/lock	\$776	85

\*Self Edge Standard

### Mobile Ped With Steel Top - Laminate Fronts (Vertical Grain Direction)

15"	28-3/4"	28"	ULTM2815B-LK	Box/Box/File w/lock	\$981	95
			ULTM2815F-LK	File/File w/lock	\$896	95

\*Self Edge Standard

NOTE: Posting shelves may be added to 28-3/4 pedestals. Simply add "-PS" suffix and add \$179 to list price.

	Notes	Catalog	List Price	Ship Weight
--	-------	---------	------------	-------------

## Accessories

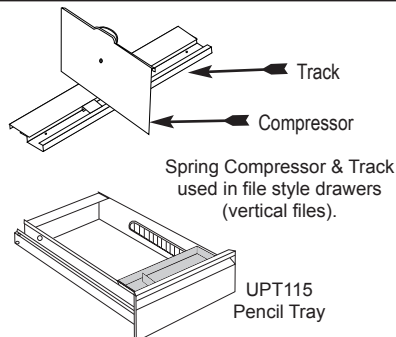

DIV15  
Box Drawer Di-  
vider

Spring Compressor & Track  
used in file style drawers  
(vertical files).

UPT115  
Pencil Tray

Box Drawer Divider	DIV15	\$ 29	.5
Spring Compressor &Track 22"	VPCT22	\$ 46	.5
Spring Compressor & Track 28"	VPCT28	\$ 46	.5
Spring Compressor (wo/Track)	L-62-DIP	\$ 36	.25
Pencil Tray	UPT115	\$ 58	.5
Ultraped Caster Kit	UPCK	\$178	

\* See notes on top of page 16 regarding description of UPCK.

Lock Kit F Pedestal	LKUF*	\$ 46	.5
Lock Kit B Pedestal	LKUB*	\$ 46	.5
Lock Kit Suspended Ped	LKUS*	\$ 46	.5

\* These may be field installed.

Note: Box drawer includes one DIV15 divider. Additional DIV15 may be purchased. See pricing on this page. DIV15 measure 12-1/6W x 4H.

File drawers have full height sides for hanging folders.  
Compressors may be added at an upcharge if specified on order.

# Table Accessories & Center Drawers

Pedestals & Accessories

	Dimensions	Catalog Number	Notes	List Price	Ship Weight
--	------------	----------------	-------	------------	-------------

## Center Drawer/Keyboard Drawer

W x D

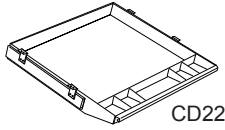

CD22

20-3/4" X 22-3/8"

CD22

2" high center drawer mounts under work surface. 5 front compartments. No lock.

\$178

13

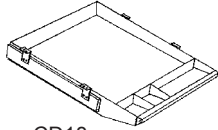

CD18

15-1/2" x 22-3/8"

CD18

Same as above with 3 front compartments.

\$174

11

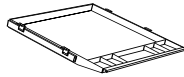

CD15

12" x 11-3/4"

CD15

2" high center drawer mounts under work surface. 1 front compartment. No lock.

\$122

8

All are approximately 1-1/2" high.

**22"W x 18-3/8"D**

CD22P

Plastic Center Drawer  
Non-locking

\$93

## Center Drawer Lock

LK

Lock Option

\$39

10

Order Example: CD22LK

\$217



FH2

20" x 11"  
w/7-1/2"x 8-1/2"  
Mouse Surface

FH2

Plastic under desk keyboard Tray.  
Black Only

\$81

W D H

## Casters

1-7/8" 2-1/4" 2-1/2"

UPCK

Four (4) 2-1/2" Casters  
All non-locking  
All swivel

\$178



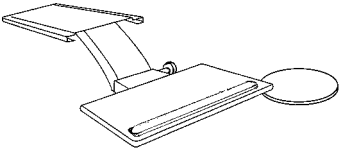
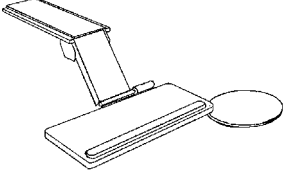

# Ergonomic Accessories

	Dimensions	Catalog Number	Notes	List Price
<b>Articulating Keyboard</b>				
	20 3/4" x 11"	AKB	5 3/4" Height Adj. Spring Assist 17 3/4" Track +/- 15 Degree Tilt Adj. Swivel Mouse Tray 360 Degree Rear Swivel Single knob sets both height & tilt of keyboard tray - Black	\$309
AKB				
	20 3/4" x 11"	AKD	5 1/4" Height Adj. Spring Assist 20" Track +/- 15 Degree Tilt Adj. Swivel and Tilting Mouse Tray 360 Degree Rear Swivel Lift and Set Height Adj. Knob Tilt Adj. - Black Shipping Weight 8lbs.	\$358
AKD				

Pedestals & Accessories

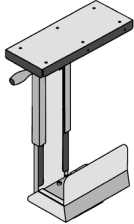
# CPU & Monitor Accessories

	Dimensions	Catalog Number	Notes	List Price
<b>CPU Holders</b>				
(Mounting Plate) →	5 1/2" to 11 5/8" width Adjustment and 5 to 13 1/2" Height adjustment	CPUH (black only)	CPU holder attaches vertically to underside of worksurface; Slides out on a 19.75" ball bearing track for easy access to cable connection. Full 360° swivel.	\$250
CPUH	Line Art may not depict actual product furnished			
	5" to 9" width Adjustment	VCPU-8 (black only)	Budget CPU holder; attaches vertically to underside of worksurface; slides and Swivels.	\$136
VCPU-8	Line Art may not depict actual product furnished			
		VCPU-9	CPU Trolley	\$132
<b>Flat Monitor Support</b>				
	16" extension	MTR825	Dual Arm /Single Monitor 15" Height Adj. at Column +/- Height Adj. at forward pivot Swivel & Tilt +/- 90 degrees Rotation 180 degrees Monitor capacity 25 lbs Silver	\$354
MTR825				

# Storage

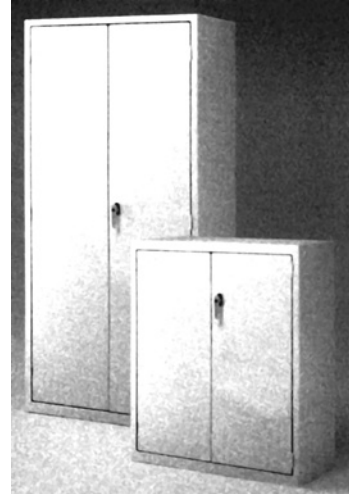

## GENERAL PRODUCT INFORMATION

### Storage Cabinets

- Storage cabinets are 18-1/8" deep and available in 30", 36" and 42" widths.
- Storage cabinet heights are 27-11/16", 39-13/16" and 65-1/4". These heights match the heights of 2, 3 & 5 drawer Bentson lateral files respectively.
- Locks are standard on all storage cabinets except sliding door cabinets with prefix of SCS". Locks may be keyed alike to like storage cabinets. This must be specified at time of order.
- Reinforced top and base with leveling glides are standard on all storage cabinets.

### Technology Command Centers \*NEW\*

- Secure locking storage units for your technology componentry, measuring 30" wide x 25" deep x 29" high with laminate top (27-11/16" high with steel top).
- 3 adjustable shelves provide 4 storage compartments on one side with a 9-1/2" wide Tower CPU Storage area in the other. Rear access for ease in wiring components. Side and back ventilation keeps technology equipment cool. One (1) standard wiring grommet located above CPU compartment.
- Locking double front doors feature integral full pulls.
- Mobile caster option available

### Storage Towers

- A variety of cabinets are available combining file storage, wardrobe storage and bulk storage.
- Storage towers are available in 18-1/8" and 24" depths.
- Storage towers are available in 24", 30" and 42" widths.
- Lateral file drawers are equipped for side-to-side hanging folders, letter or legal size.

### File Center

- File center is 18-1/8" deep x 30" wide x 27-11/16" high. This matches the height of the Bentson 2 drawer lateral files.
- File features 2 box drawers, 1 letter file drawer and one lateral file drawer. Lateral file drawer is equipped for side-to-side hanging folders, letter or legal size.
- Optional lock may be keyed alike at no upcharge. This must be specified at time of order.

### Bookcases

- Bookcases are 12" deep and 36" wide. Bookcases are available in 29", 44", 56" and 72" heights.
- Bookcases are all steel construction and standard with adjustable leveling glides.
- Bookcases are available with 3 top styles. SW suffix denotes steel top, waterfall front edge. SE suffix denotes high pressure laminate top, self edge, Wood Core. Part numbers without a suffix denotes Steel top, square front edge.
- Bookcase shelves are adjustable on 9/16" centers.
- The openings of the 44" and 56" high bookcases will accommodate 3 ring binders.
- Bookcases to match the heights of Bentson lateral files are available. Please consult customer service for price and availability.

# Storage

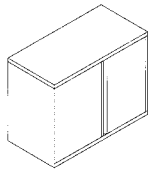

Catalog Number	Dimensions W x D x H	Description	List Price	Ship Weight
<b>Storage Cabinets</b>				
SC3027LK	30 x 18-1/8 x 27-11/16	Cabinet with locking hinged doors,	\$938	163
SC3627LK	36 x 18-1/8 x 27-11/16	full length pull, 1 adjustable shelf.	\$1026	182
SC4227LK	42 x 18-1/8 x 27-11/16	With Lock.	\$1067	201
SC3027HLK	30 x 18-1/8 x 27-11/16	Cabinet with locking hinged doors,	\$977	163
SC3627HLK	36 x 18-1/8 x 27-11/16	1 adjustable shelf, with handle pull	\$1062	182
SC4227HLK	42 x 18-1/8 x 27-11/16	style lock.	\$1101	201

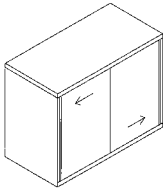

SCS3027	30 x 18-1/8 x 27-11/16	Sliding doors with full length	\$891	173
SCS3627	36 x 18-1/8 x 27-11/16	pull, 1 adjustable shelf, non-locking.	\$922	192
SCS4227	42 x 18-1/8 x 27-11/16	No Lock.	\$963	211

• Suffix 'LK' for locking - May be keyed alike with other products Add \$60

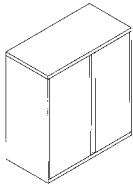

SC3039LK	30 x 18-1/8 x 39-13/16	Cabinet with locking hinged doors,	\$1107	170
SC3639LK	36 x 18-1/8 x 39-13/16	full length pull, 2 adjustable shelves.	\$1142	185
SC4239LK	42 x 18-1/8 x 39-13/16	With Lock	\$1184	210
SC3039HLK	30 x 18-1/8 x 39-13/16	Cabinet with locking hinged doors,	\$1139	170
SC3639HLK	36 x 18-1/8 x 39-13/16	2 adjustable shelves, with handle pull	\$1173	185
SC4239HLK	42 x 18-1/8 x 39-13/16	style lock.	\$1213	210

Catalog Number	Dimensions W x D x H	Description	List Price	Weights
----------------	-------------------------	-------------	------------	---------

## Storage Cabinets

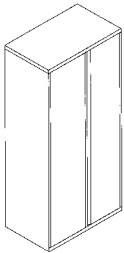

SC3065LK	30 x 18-1/8 x 65-1/4	Cabinet with locking hinged doors,	\$1253	156
SC3665LK	36 x 18-1/8 x 65-1/4	full length pull, 4 adjustable shelves.	\$1323	178
SC4265LK	42 x 18-1/8 x 65-1/4	With Lock.	\$1353	190
SC362465LK	36 x 24 x 65-1/4		\$1511	

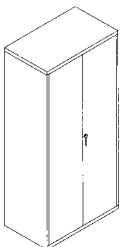

SC3065HLK	30 x 18-1/8 x 65-1/4	Same as above with 2 point	\$1288	156
SC3665HLK	36 x 18-1/8 x 65-1/4	locking turn handle. 4 adjustable shelves.	\$1347	178
SC4265HLK	42 x 18-1/8 x 65-1/4	With Lock. Cannot be keyed alike with other products	\$1366	190

# Storage



TCR3024LK-PV

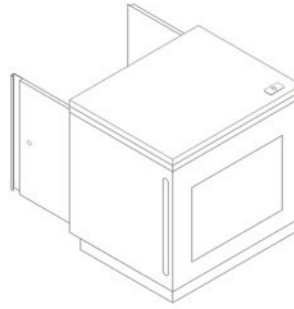

TCL3024LK-PV

\* L or R indicates on what side you wish to have shelving.

Catalog Number	Dimensions W x D x H	Description	List Price	Ship Weight
<b>Technology Command Center</b>				
TC*3024LK	30 x 24 x 27-11/16	Technology cabinet, steel top, locks	\$1823	98
TC*3024LK-PV	30 x 24 x 29	Technology cabinet, laminate top, PVC edge, locks	\$1927	115
TC*3024LK-PV-MDF	30 x 24 x 29	Technology cabinet, laminate top, PVC edge, locks, MDF particle board	\$1961	115

### PLEASE SPECIFY:

\* specify L or R for Left or Right where an asterisk is denoted in part number.

Coat Hanger

L or R indicates on what side you wish to have wardrobe compartment.

Please specify Paint Color.

### PLEASE SPECIFY:

\* specify L or R for Left or Right where an asterisk is denoted  
Please specify Paint Color.

SCWL3652LK

Catalog Number	Dimensions W x D x H	Description	List Price	Ship Weight
<b>Storage Cabinet Wardrobe Storage</b>				
SCW*3652LK	36 x 18-1/8 x 52-1/2	Wardrobe compartment on left or right Includes coat rod & single hook	\$1697	179
SCW*3665LK	36 x 18-1/8 x 65-1/4	Compartment on right has two adjustable shelves and one 12" fixed shelf, locking full pull doors	\$1876	209

# Storage (Special Order Only-Extended Lead times)

Catalog Number	Dimensions W x D x H	Description	List Price
<b>Storage Towers</b>			
STR2465LK	24 x 24 x 65-1/4	Two letter drawers with 15"W x 36"H hinged door cabinet (one adjustable shelf) and a 7" wardrobe with coat hook on right, w/lock	\$2771
STL2465LK	24 x 24 x 65-1/4	Two letter drawers with 15"W x 36"H hinged door cabinet (one adjustable shelf) and a 7" wardrobe with coat hook on left, w/lock	\$2771
ST3065BR-LK	30 x 18-1/8 x 65-1/4	Cabinet with one 30" lateral drawer One 12" letter drawer two 6" box drawers One 30" wide two shelf hinged storage unit with swing out door, w/lock	\$2920
ST3065LK-2R	30 x 18-1/8 x 65-1/4	Cabinet with two 30" lateral drawers with a 30" hinged door	\$2172
ST3665LK-2R	36 x 18-1/8 x 65-1/4	cabinet and two shelves, w/lock	\$2268
STR4265BR-LK	42 x 18-1/8 x 65-1/4	Cabinet with one 30" lateral drawer One 12" letter drawer two 6" box drawer One 30" wide two shelf storage unit and one wardrobe with coat hook on right, w/lock	\$3449
STL4265BR-LK	42 x 18-1/8 x 65-1/4	Cabinet with one 30" lateral drawer One 12" letter drawer two 6" box drawer One 30" wide two shelf storage unit and one wardrobe with coat hook on right, w/lock	\$3449
STR4265LK-2R	42 x 18-1/8 x 65-1/4	Cabinet with two 30" lateral drawers One 30" wide two shelf storage unit and one wardrobe with coat hook on right, w/lock	\$2658
STL4265LK-2R	42 x 18-1/8 x 65-1/4	Cabinet with two 30" lateral drawers One 30" wide two shelf storage unit and one wardrobe with coat hook on left, w/lock	\$2658
STR4265LK-1A4R	42 x 18-1/8 x 65-1/4	5 drawer 30" lateral drawer unit with one receding door, four R-drawers and one 12" wardrobe with coat hook on right, w/lock	\$2664
STL4265LK-1A4R	42 x 18-1/8 x 65-1/4	5 drawer 30" lateral drawer unit with one receding door, four R-drawers and One 12" wardrobe with coat hook on left, w/lock	\$2664

L or R indicates on what side you wish to have wardrobe compartment.

Storage

## File Centers

Catalog Number	Cabinet Size with Top W x D x H	Description	List Price	Ship Weight
<b>File Center ( Steel Drawer fronts only)</b>				
FC230BR	30 x 18-1/8 x 27-11/16	Cabinet with : 1 Letter Drawer 2 Box Drawers and 1 side to side lateral drawer No Lock	\$2632	
FC230BR-LK	30 x 18-1/8 x 27-11/16	Same as above With lock	\$2679	

# Storage

## Bookcases

	Catalog Number	Cabinet Size with Top W x D x H	Description	List Price	Ship Weight
	BC361229	36 x 12 x 29	1 shelf /2 spaces, 12-3/16"H	\$502	70
	BC361236	36 x 12 x 36	1 shelf /2 spaces, 15-7/8"H	\$554	90
	BC361244	36 x 12 x 44	2 shelf /3 spaces, 12-7/8"H	\$635	110
	BC361256	36 x 12 x 56	3 shelf /4 spaces, 12-1/4" H	\$704	130
	BC361272	36 x 12 x 72	4 shelf /5 spaces, 12-7/8"H	\$785	136
Steel square front top					
	BC361365	36 x 13 x 65	4 shelf /5 spaces	\$739	133
	BC361836	36 x 18 x 36	1 shelf /2 spaces, 15-7/8"H	\$777	82
	BC361865	36 x 18 x 65	4 shelf /5 spaces	\$949	

## Storage



Steel waterfall front top

BC361229-SW	36 x 12 x 29	1 shelf /2 spaces, 12-3/16"H	\$603	70
BC361244-SW	36 x 12 x 44	2 shelf /3 spaces, 12-7/8"H	\$653	110
BC361256-SW	36 x 12 x 56	3 shelf /4 spaces at 12-1/4" H	\$762	130
BC361272-SW	36 x 12 x 72	4 shelf /5 spaces, 12-7/8"H	\$831	136
BC361284-SW	36 x 12 x 84	4 shelf /5 spaces, 12-7/8"H	\$1062	144



Self-edge laminate top.  
\$25 net upcharge for PVC edge.

BC361229-SE	36 x 12 x 29	1 shelf /2 spaces, 12-3/16"H	\$653	70
BC361244-SE	36 x 12 x 44	2 shelf /3 spaces, 12-7/8"H	\$704	110
BC361256-SE	36 x 12 x 56	3 shelf /4 spaces at 12-1/4" H	\$854	130
BC361272-SE	36 x 12 x 72	4 shelf /5 spaces, 12-7/8"H	\$947	136

### Bookcase Shelf (extra)

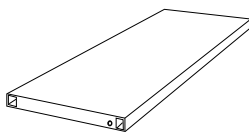

BCS3612	36" x 12"	Specify enamel color choice. Clips included.	\$87	8
BCS3618	36" x 18"	Specify enamel color choice. Clips included.	\$99	8
MD-19-D-1		Bookshelf Clips	\$ .85 each	1

**NOTE:** Bookcases are offered with three style tops:  
Square Steel Top Front, SE = Self-edge or SW =Steel waterfall front edge.



# Lateral Files

---



## GENERAL PRODUCT INFORMATION

### **Bentson Lateral Files – Full Pull 12" High Drawers**

- Files are 18-1/8" deep.
- Files are available in 30", 36" and 42" widths.
- Series includes 2 drawer (27-11/16"H), 3 drawer (39-13/16"H), 4 drawer (53-1/8"H) and 5 drawer (65-1/4"H) files.
- Heavy duty ball bearing suspension and interlock system standard in all files.
- Welded vertical seam in back of cabinets.
- Posting shelf option available on 4 drawer and 5 drawer files.
- Various drawer interior options available.
- Overfiles and laminate tops available.
- Counterweights recommended for freestanding files.
- Locks may be keyed alike to other pedestals, center drawers, verticals, laterals, etc. This must be specified at time of order.
- Locks may be field installed IF laterals were manufactured/purchased after 3-25-2011.
- Cylindrical lock "cores" may be replaced or changed out in the field.

### **Independence Lateral Files – Full Pull 10-1/2" High Drawers**

- Files are 18-1/8" Deep
- Available in 30", 36" and 42" widths
- Fixed drawers fronts only. No recessed doors available. "R" option only
- Heavy duty ball bearing suspensions and interlock system standard
- Welded vertical seam in back of cabinets
- Counterweights recommended for freestanding files.
- Locks may be keyed alike to other pedestals, center drawers, verticals, laterals, etc. This must be specified at time of order.
- Locks may be field installed IF laterals were manufactured/purchased after 3-25-2011.
- Cylindrical lock "cores" may be replaced or changed out in the field.

# Independence Lateral Files

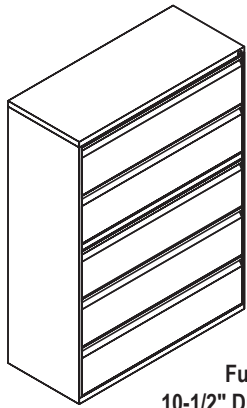

Full Pull  
10-1/2" Drawer Height

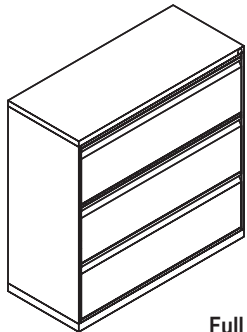
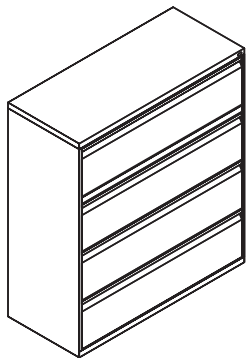

Full Pull  
10-1/2" Drawer Height

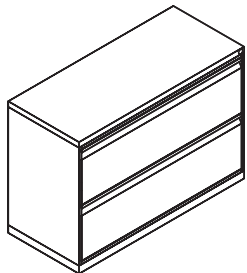

Fixed drawers fronts only.  
No recessed doors available.  
"R" option only

Laterals

Catalog Number	Dimensions W x D x H	Description	List Price	Ship Weight
<b>Five drawer - Fixed drawer fronts only</b>				
I530-5R	30 x 18-1/8 x 57-5/8	Letter or legal depth drawer	\$1978	190
I530LK-5R	30 x 18-1/8 x 57-5/8	Letter or legal depth drawer, locks	\$1996	192
I536-5R	36 x 18-1/8 x 57-5/8	Letter or legal depth drawer	\$2049	260
I536LK-5R	36 x 18-1/8 x 57-5/8	Letter or legal depth drawer, locks	\$2082	262
I542-5R	42 x 18-1/8 x 57-5/8	Letter or legal depth drawer	\$2247	330
I542LK-5R	42 x 18-1/8 x 57-5/8	Letter or legal depth drawer, locks	\$2281	332
<b>Four drawer - Fixed drawer fronts only</b>				
I430-4R	30 x 18-1/8 x 47-3/4	Letter or legal depth drawer	\$1616	150
I430LK-4R	30 x 18-1/8 x 47-3/4	Letter or legal depth drawer, locks	\$1643	152
I436-4R	36 x 18-1/8 x 47-3/4	Letter or legal depth drawer	\$1643	205
I436LK-4R	36 x 18-1/8 x 47-3/4	Letter or legal depth drawer, locks	\$1681	207
I442-4R	42 x 18-1/8 x 47-3/4	Letter or legal depth drawer	\$1796	260
I442LK-4R	42 x 18-1/8 x 47-3/4	Letter or legal depth drawer, locks	\$1840	262
<b>Three drawer - Fixed drawer fronts only</b>				
I330-3R	30 x 18-1/8 x 35-3/8	Letter or legal depth drawer	\$1251	121
I330LK-3R	30x 18-1/8 x 35-3/8	Letter or legal depth drawer, locks	\$1283	123
I336-3R	36 x 18-1/8 x 35-3/8	Letter or legal depth drawer	\$1295	142
I336LK-3R	36 x 18-1/8 x 35-3/8	Letter or legal depth drawer, locks	\$1316	144
I342-3R	42 x 18-1/8 x 35-3/8	Letter or legal depth drawer	\$1410	163
I342LK-3R	42 x 18-1/8 x 35-3/8	Letter or legal depth drawer, locks	\$1431	165
<b>Two drawer - Fixed drawer fronts only</b>				
I230-2R	30 x 18-1/8 x 24-3/4	Letter or legal depth drawer	\$911	111
I230LK-2R	30 x 18-1/8 x 24-3/4	Letter or legal depth drawer, locks	\$949	113
I236-2R	36 x 18-1/8 x 24-3/4	Letter or legal depth drawer	\$947	130
I236LK-2R	36 x 18-1/8 x 24-3/4	Letter or legal depth drawer, locks	\$964	132
I242-2R	42 x 18-1/8 x 24-3/4	Letter or legal depth drawer	\$1137	149
I242LK-2R	42 x 18-1/8 x 24-3/4	Letter or legal depth drawer, locks	\$1069	151

\* Counterweights are recommended. Please refer to page 32.

# Bentson Lateral Files

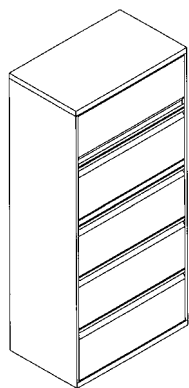

Full Pull

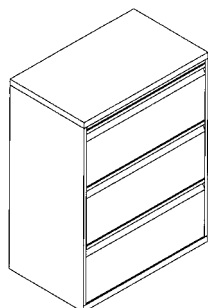
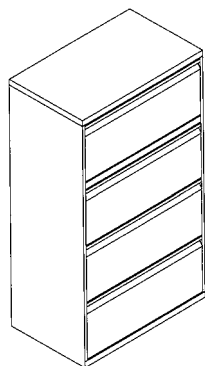

Full Pull

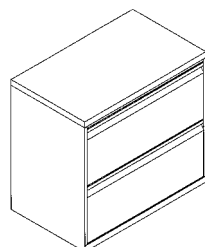

Catalog Number	Dimensions W x D x H	Description	List Price	Ship Weight
<b>Six drawer</b>				
C636LK-SH6	36 x 18-1/8 x 76-1/2	Six High   Six Shelves	\$2687	344
<b>Five drawer</b>				
C530	30 x 18-1/8 x 65-1/4	Letter or legal depth drawer	\$2020	195
C530LK	30 x 18-1/8 x 65-1/4	Letter or legal depth drawer, locks	\$2056	197
C536	36 x 18-1/8 x 65-1/4	Letter or legal depth drawer	\$2109	265
C536LK	36 x 18-1/8 x 65-1/4	Letter or legal depth drawer, locks	\$2142	267
C542	42 x 18-1/8 x 65-1/4	Letter or legal depth drawer	\$2322	335
C542LK	42 x 18-1/8 x 65-1/4	Letter or legal depth drawer, locks	\$2358	337
<b>NOTE: Top drawer receding comes standard with five (5) drawer lateral.</b>				
<b>Four drawer</b>				
C430	30 x 18-1/8 x 53-1/8	Letter or legal depth drawer	\$1662	155
C430LK	30 x 18-1/8 x 53-1/8	Letter or legal depth drawer, locks	\$1696	157
C436	36 x 18-1/8 x 53-1/8	Letter or legal depth drawer	\$1696	210
C436LK	36 x 18-1/8 x 53-1/8	Letter or legal depth drawer, locks	\$1736	212
C442	42 x 18-1/8 x 53-1/8	Letter or legal depth drawer	\$1858	265
C442LK	42 x 18-1/8 x 53-1/8	Letter or legal depth drawer, locks	\$1898	267
<b>Posting Shelf</b>				
PS	30 x 1-1/8	Posting Shelf installed above third drawer	\$162	
	36 x 1-1/8	Available in 4 or 5 drawer	\$181	
	42 x 1-1/8	(ex: C530LK-1A4R-PS)	\$198	
<b>Three drawer</b>				
C330	30 x 18-1/8 x 39-13/16	Letter or legal depth drawer	\$1290	126
C330LK	30 x 18-1/8 x 39-13/16	Letter or legal depth drawer, locks	\$1324	128
C336	36 x 18-1/8 x 39-13/16	Letter or legal depth drawer	\$1326	147
C336LK	36 x 18-1/8 x 39-13/16	Letter or legal depth drawer, locks	\$1362	149
C342	42 x 18-1/8 x 39-13/16	Letter or legal depth drawer	\$1441	168
C342LK	42 x 18-1/8 x 39-13/16	Letter or legal depth drawer, locks	\$1478	170
<b>Two drawer</b>				
C230	30 x 18-1/8 x 27-11/16	Letter or legal depth drawer	\$927	116
C230LK	30 x 18-1/8 x 27-11/16	Letter or legal depth drawer, locks	\$966	118
C236	36 x 18-1/8 x 27-11/16	Letter or legal depth drawer	\$956	135
C236LK	36 x 18-1/8 x 27-11/16	Letter or legal depth drawer	\$993	137
C242	42 x 18-1/8 x 27-11/16	Letter or legal depth drawer	\$1058	154
C242LK	42 x 18-1/8 x 27-11/16	Letter or legal depth drawer, locks	\$1093	156

Laterals

\* Counterweights are recommended. Please refer to page 32.

See Page 31 for drawer options. Example of how a part number looks as a whole when it includes drawer options chosen: C530LK-1A4R

# Drawer & Drawer Interior Options

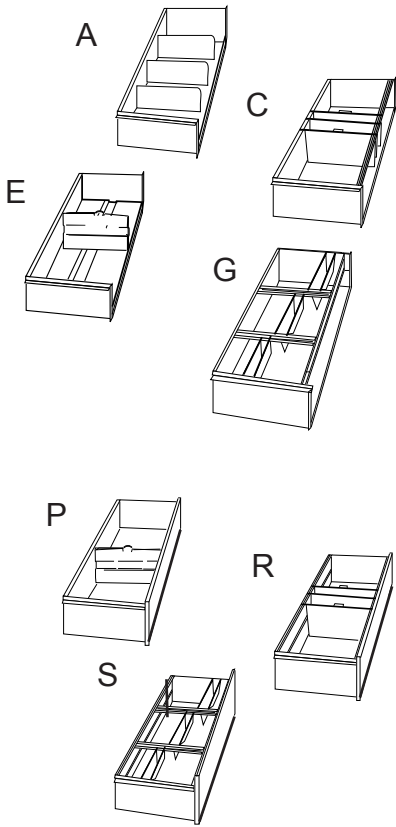

Option Suffix	Description	List Price
<b>30", 36" and 42" wide</b>		
A	Receding drawer front. Roll-out shelf with 3 dividers.	Add \$61 per drawer
C	Receding drawer front. Roll-out shelf with lengthwise hanging folder frame.	Add \$61 per drawer
E	Receding drawer front. Roll-out shelf with compressor.	Call factory for availability & pricing.
G	Receding drawer front. Roll-out shelf with front to back hanging folder frames. Specify letter size use: 2 rows in 36" drawer. 3 rows in 42" drawer. Specify legal size use: 2 rows in 36" and 42" drawer.	Add \$61 per drawer
P	Roll-out fixed front, drawer. Compressor for side to side filing.	Call factory for availability & pricing.
R	Roll-out fixed front drawer. Hanging folder frames for side to side filing.	No Upcharge
S	Roll-out fixed front, drawer. Hanging folder frames for front to back filing.	Add \$24 - 1 drawer file Add \$29 - 2 drawer file Add \$35 - 3 drawer file Add \$41 - 4 drawer file Add \$47 - 5 drawer file

Specify letter size use:  
 > 2 rows in 30" and 36" drawer.  
 > 3 rows in 42" drawer.

**NOTE:** When ordering a 5 drawer Lateral, there is no additional charge for top drawer as it relates to options A, C or E (not G).

**EX:** C542LK-2C3S = Base Price + n/cfor top drawer + \$61 for drw 2 + \$35 drw style S [Per file - not per drawer]

## Drawer Interior Options

Catalog Number	Dimensions W x D x H	Description	List Price
<b>Hanging Folder Frames – Letter and legal depth</b>			
<u>Side to Side - Bentson</u>			
BHF30	30" W		\$61 pr
BHF36	36" W		
BHF42	42" W		
<u>Side to Side - Independence</u>			
IHF30	30" W		\$61 pr
IHF36	36" W		
IHF42	42" W		
<u>Front to Back - Bentson</u>			
BFB		Order pair of rails for each compartment. Two cross rails required to install front to back hanging frame rails.	\$61 pr



When specifying drawer interiors, list options beginning with the top drawer and continue in descending order for each drawer.

Example: C530LK-1A4R

C 5 5 drawers – Bentson  
 30 30" wide  
 LK Locking  
 1A top drawer receding  
 4R 4 drawer r option

# Lateral File Accessories

## Laminate Tops for Lateral Files

Used with Bentson/Independence Series laterals

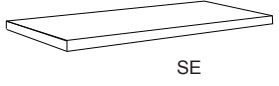
	Catalog Number	Dimensions W x D	Description	List Price	Ship Weight
	TL3018-SE	30-1/8 x 18-3/8	Wood core.	\$171	25
	TL3618-SE	36-1/8 x 18-3/8	Self-edge laminate top.	\$204	29
	TL4218-SE	42-1/8 x 18-3/8		\$228	33
	TL6018-SE	60 x 18-3/8		\$322	44
	TL7218-SE	72 x 18-3/8		\$344	56
	TL8418-SE	84 x 18-3/8		\$365	66

## Waterfall Edge

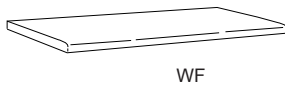
	TL3018-WF	30-1/8 x 18-3/8	Wood core.	\$268	25
	TL3618-WF	36-1/8 x 18-3/8	Waterfall front edge laminate top.	\$282	29
	TL4218-WF	42-1/8 x 18-3/8	Back and sides self-edge.	\$304	33
	TL6018-WF	60 x 18-3/8		\$365	44
	TL7218-WF	72 x 18-3/8		\$402	56
	TL8418-WF	84 x 18-3/8		\$481	66

## PVC Edge

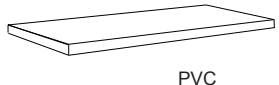
	TL3018-PV	30-1/8 x 18-3/8	Wood core.	\$229	25
	TL3618-PV	36-1/8 x 18-3/8	PVC edge laminate top.	\$261	29
	TL4218-PV	42-1/8 x 18-3/8	Back and sides self-edge.	\$286	33
	TL6018-PV	60 x 18-3/8		\$380	44
	TL7218-PV	72 x 18-3/8		\$402	56
	TL8418-PV	84 x 18-3/8		\$423	66

Laterals

### **NOTE:**

**For information on additional compressors, please refer to page 20 at the bottom of page under Accessories.**

## Counterweights

Used with Bentson/Independence Series laterals

CW30	30" wide	\$153	18
CW36	36" wide	\$179	20
CW42	42" wide	\$207	22

Note: Installation of counterweights is recommended for freestanding files (i.e. files that are not positioned under a work surface, ganged to an adjacent file or bolted to the wall or (floor). One weight per cabinet required. 5-drawer laterals passed BIFMA tests without weights but for a safety factor of 10 lbs, add (1) weight.

# Vertical Files

---



## GENERAL PRODUCT INFORMATION

### 1100 [ HSA & HSB ] / 1400 [ HSA ] / 3400 [ HSB ] / Bentson Series [ HSA & HSB ]

- These series vertical files are available in a variety of heights: 2 drawer (29"H), 3 drawer (39-7/8"H), 4 drawer (52"H), and 5 drawer (60-7/8"H). All files use a 3-piece body welded construction. Heavy gauge steel cross members combined with welded top and bottom form a rigid case assembly.
- HSA series use traditional style brushed aluminum handles with positive thumb latch catch for anti-rebound.
- HSB series has full width folded recessed drawer pull and uses anti-rebound case channels to prevent unintentional opening of more than one drawer at a time.
- Verticals are a full 28" deep, letter and legal width sizes.
- Letter or legal width files come standard with high side drawers and may be ordered with a quick release compressor.
- A single lock controls all drawers. The lock may be field or factory installed and are keyed at random. Specify if to be keyed alike to other units.
- Replacement locks and master key locks are available.
- Security lock bars (SLB) are welded to the outside of file and must be secured with a padlock. Padlock is not provided.
- Maximum weight capacity is 75 pounds per drawer

### Suspensions

- 1100 Series Vertical File Cabinets have 3 Segment Progressive Suspension
- The 1400 and 3400 Series Vertical File Cabinets have Nylon Roller Cradle Suspension
- The Bentson Series Vertical File Cabinets have Nylon-Tired Steel Ball Bearing Cradle Suspension

# 1100 Series 28" Deep

3 Segment Progressive Suspension / High Side Drawers

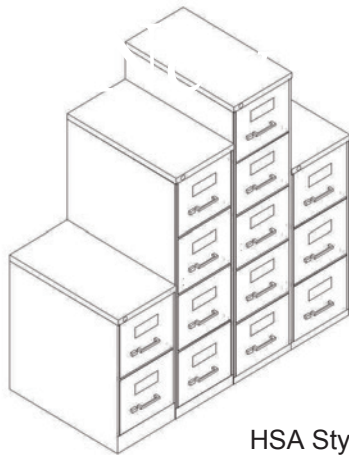

HSA Style Fronts

**NOTE:** The 1100 Series is also available in HSB full integral pull style front. Pricing is the same as the HSA equivalent.

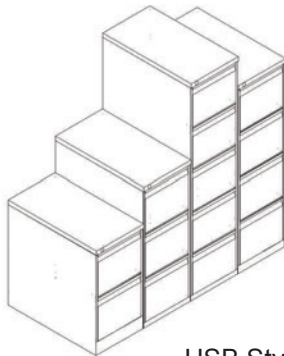

HSB Style Fronts

**NOTE:** Leveling glides may be added. Simply add “-LG” suffix to item number and add **\$52** to list price.

Catalog Number	Dimensions W x D x H	Description	List Price	Ship Weight
<b>Five drawer – 60-7/8" high with steel top</b>				
1150HSA	15 x 28 x 60-7/8	Letter width, high side	\$1201	178
1150HSA-LK	15 x 28 x 60-7/8	Letter width, high side, locks	\$1287	180
1151HSA	18-1/8 x 28 x 60-7/8	Legal width, high side	\$1345	195
1151HSA-LK	18-1/8 x 28 x 60-7/8	Legal width, high side, locks	\$1418	197
1150HSA-CP	15 x 28 x 60-7/8	Letter width, compressors	\$1285	178
1150HSA-CP-LK	15 x 28 x 60-7/8	Letter width, compressors, locks	\$1322	180
1151HSA-CP	18-1/8 x 28 x 60-7/8	Legal width, compressors	\$1429	195
1151HSA-CP-LK	18-1/8 x 28 x 60-7/8	Legal width, compressors, locks	\$1465	197
<b>Four drawer – 52" high with steel top</b>				
1140HSA	15 x 28 x 52	Letter width, high side	\$1003	150
1140HSA-LK	15 x 28 x 52	Letter width, high side, locks	\$1062	152
1141HSA	18-1/8 x 28 x 52	Legal width, high side	\$1118	162
1141HSA-LK	18-1/8 x 28 x 52	Legal width, high side, locks	\$1183	164
1140HSA-CP	15 x 28 x 52	Letter width, compressors	\$1069	150
1140HSA-CP-LK	15 x 28 x 52	Letter width, compressors, locks	\$1118	152
1141HSA-CP	18-1/8 x 28 x 52	Legal width, compressors	\$1159	162
1141HSA-CP-LK	18-1/8 x 28 x 52	Legal width, compressors, locks	\$1219	164
<b>Three drawer – 39-7/8" high with steel top</b>				
1130HSA	15 x 28 x 39-7/8	Letter width, high side	\$889	115
1130HSA-LK	15 x 28 x 39-7/8	Letter width, high side, locks	\$961	117
1131HSA	18-1/8 x 28 x 39-7/8	Legal width, high side	\$991	126
1131HSA-LK	18-1/8 X 28 X 39-7/8	Legal width, high side, locks	\$1033	128
1130HSA-CP	15 x 28 x 39-7/8	Letter width, compressors	\$936	115
1130HSA-CP-LK	15 x 28 x 39-7/8	Letter width, compressors, locks	\$1007	117
1131HSA-CP	18-1/8 x 28 x 39-7/8	Legal width, compressors	\$1039	126
1131HSA-CP-LK	18-1/8 x 28 x 39-7/8	Legal width, compressor, locks	\$1069	128
<b>Two drawer – 29" high with steel top</b>				
1120HSA	15 x 28 x 29	Letter width, high side	\$649	86
1120HSA-LK	15 x 28 x 29	Letter width, high side, locks	\$715	88
1121HSA	18-1/8 x 28 x 29	Legal width, high side	\$721	92
1121HSA-LK	18-1/8 x 28 x 29	Legal width, high side, locks	\$784	94
1120HSA-CP	15 x 28 x 29	Letter width, compressors	\$685	86
1120HSA-CP-LK	15 x 28 x 29	Letter width, compressors, locks	\$739	88
1121HSA-CP	18-1/8 x 28 x 29	Legal width, compressors	\$753	92
1121HSA-CP-LK	18-1/8 x 28 x 29	Legal width, compressors, locks	\$807	94



For information on security lock bars please refer to page 38.

Verticals

# 1400 Series 28" Deep

Nylon Roller Cradle Suspension / High Side Drawers

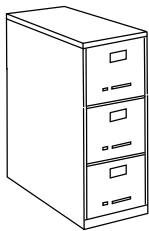
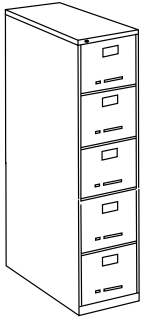

Catalog Number	Dimensions W x D x H	Description	List Price	Ship Weight
----------------	----------------------	-------------	------------	-------------

### Five drawer – 60-7/8" high with steel top

1450HSA	15 x 28 x 60-7/8	Letter width, high side	\$1272	178
1450HSA-LK	15 x 28 x 60-7/8	Letter width, high side, locks	\$1337	180
1451HSA	18-1/8 x 28 x 60-7/8	Legal width, high side	\$1399	195
1451HSA-LK	18-1/8 x 28 x 60-7/8	Legal width, high side, locks	\$1467	197
1450HSA-CP	15 x 28 x 60-7/8	Letter width, compressors	\$1341	178
1450HSA-CP-LK	15 x 28 x 60-7/8	Letter width, compressors, locks	\$1410	18
1451HSA-CP	18-1/8 x 28 x 60-7/8	Legal width, compressors	\$1490	195
1451HSA-CP-LK	18-1/8 x 28 x 60-7/8	Legal width, compressors, locks	\$1543	197

### Four drawer – 52" high with steel top

1440HSA	15 x 28 x 52	Letter width, high side	\$1041	150
1440HSA-LK	15 x 28 x 52	Letter width, high side, locks	\$1111	152
1441HSA	18-1/8 x 28 x 52	Legal width, high side	\$1154	162
1441HSA-LK	18-1/8 x 28 x 52	Legal width, high side, locks	\$1224	164
1440HSA-CP	15 x 28 x 52	Letter width, compressors	\$1088	150
1440HSA-CP-LK	15 x 28 x 52	Letter width, compressors, locks	\$1161	152
1441HSA-CP	18-1/8 x 28 x 52	Legal width, compressors	\$1212	162
1441HSA-CP-LK	18-1/8 x 28 x 52	Legal width, compressors, locks	\$1281	164

### Three drawer – 39-7/8" high with steel top

1430HSA	15 x 28 x 39-7/8	Letter width, high side	\$909	115
1430HSA-LK	15 x 28 x 39-7/8	Letter width, high side, locks	\$984	117
1431HSA	18-1/8 x 28 x 39-7/8	Legal width, high side	\$1020	126
1431HSA-LK	18-1/8 x 28 x 39-7/8	Legal width, high side, locks	\$1053	128
1430HSA-CP	15 x 28 x 39-7/8	Letter width, compressors	\$950	115
1430HSA-CP-LK	15 x 28 x 39-7/8	Letter width, compressors, locks	\$1024	117
1431HSA-CP	18-1/8 x 28 x 39-7/8	Legal width, compressors	\$1064	126
1431HSA-CP-LK	18-1/8 x 28 x 39-7/8	Legal width, compressor, locks	\$1094	128

### Two drawer – 29" high with steel top

1420HSA	15 x 28 x 29	Letter width, high side	\$686	86
1420HSA-LK	15 x 28 x 29	Letter width, high side, locks	\$749	88
1421HSA	18-1/8 x 28 x 29	Legal width, high side	\$773	92
1421HSA-LK	18-1/8 x 28 x 29	Legal width, high side, locks	\$844	94
1420HSA-CP	15 x 28 x 29	Letter width, compressors	\$710	86
1420HSA-CP-LK	15 x 28 x 29	Letter width, compressors, locks	\$777	88
1421HSA-CP	18-1/8 x 28 x 29	Legal width, compressors	\$799	92
1421HSA-CP-LK	18-1/8 x 28 x 29	Legal width, compressors, locks	\$844	94

### Two drawer - 27-3/4" high with steel top

1420SHSA	15 x 28 x 27-3/4	Letter width, high side	\$753	85
1420SHSA-LK	15 x 28 x 27-3/4	Letter width, high side, locks	\$773	87

**NOTE:** Laminated tops are available for the 1420HSA-28 and the 1420HSA-LK-28 models. This is a special. Call factory for pricing.



HSA Style Fronts

Verticals

HSA = high side, brushed aluminum pull, thumb latch, label holder

NOTE: Leveling glides may be added.

Simply add "-LG" suffix to item number and add **\$52** to list price.

'HF' hang frame files cabinets are non-standard. May be ordered as specials.

Call factory at 877.682.4601 for pricing.



# 3400 Series 28" Deep

Nylon Roller Cradle Suspension / High Side Drawers

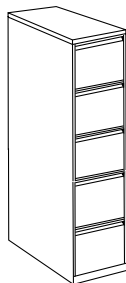

Catalog Number	Dimensions W x D x H	Description	List Price	Ship Weight
<b>Five drawer – 60-7/8" high with steel top</b>				
3450HSB	15 x 28 x 60-7/8	Letter width, high side	\$1430	178
3450HSB-LK	15 x 28 x 60-7/8	Letter width, high side, locks	\$1496	180
3451HSB	18-1/8 x 28 x 60-7/8	Legal width, high side	\$1521	195
3451HSB-LK	18-1/8 x 28 x 60-7/8	Legal width, high side, locks	\$1592	197
3450HSB-CP	15 x 28 x 60-7/8	Letter width, compressors	\$1496	178
3450HSB-CP-LK	15 x 28 x 60-7/8	Letter width, compressors, locks	\$1563	180
3451HSB-CP	18-1/8 x 28 x 60-7/8	Legal width, compressors	\$1606	195
3451HSB-CP-LK	18-1/8 x 28 x 60-7/8	Legal width, compressors, locks	\$1678	197

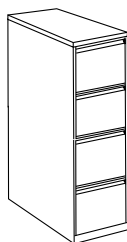

<b>Four drawer – 52" high with steel top</b>				
3440HSB	15 x 28 x 52	Letter width, high side	\$1176	150
3440HSB-LK	15 x 28 x 52	Letter width, high side, locks	\$1248	152
3441HSB	18-1/8 x 28 x 52	Legal width, high side	\$1278	162
3441HSB-LK	18-1/8 x 28 x 52	Legal width, high side, locks	\$1317	164
3440HSB-CP	15 x 28 x 52	Letter width, compressors	\$1224	150
3440HSB-CP-LK	15 x 28 x 52	Letter width, compressors, locks	\$1299	152
3441HSB-CP	18-1/8 x 28 x 52	Legal width, compressors	\$1308	162
3441HSB-CP-LK	18-1/8 x 28 x 52	Legal width, compressors, locks	\$1381	164

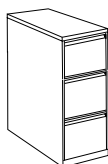

<b>Three drawer – 39-7/8" high with steel top</b>				
3430HSB	15 x 28 x 39-7/8	Letter width, high side	\$984	115
3430HSB-LK	15 x 28 x 39-7/8	Letter width, high side, locks	\$1039	117
3431HSB	18-1/8 x 28 x 39-7/8	Legal width, high side	\$1051	126
3431HSB-LK	18-1/8 x 28 x 39-7/8	Legal width, high side, locks	\$1066	128
3430HSB-CP	15 x 28 x 39-7/8	Letter width, compressors	\$1017	115
3430HSB-CP-LK	15 x 28 x 39-7/8	Letter width, compressor, locks	\$1082	117
3431HSB-CP	18-1/8 x 28 x 39-7/8	Legal width, compressors	\$1099	126
3431HSB-CP-LK	18-1/8 x 28 x 39-7/8	Legal width, compressors, locks	\$1161	128

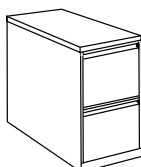

<b>Two drawer – 29" high with steel top</b>				
3420HSB	15 x 28 x 29	Letter width, high side	\$755	86
3420HSB-LK	15 x 28 x 29	Letter width, high side, locks	\$795	88
3421HSB	18-1/8 x 28 x 29	Legal width, high side	\$825	92
3421HSB-LK	18-1/8 x 28 x 29	Legal width, high side, locks	\$859	94
3420HSB-CP	15 x 28 x 29	Letter width, compressors	\$773	86
3420HSB-CP-LK	15 x 28 x 29	Letter width, compressors, locks	\$852	88
3421HSB-CP	18-1/8 x 28 x 29	Legal width, compressors	\$826	92
3421HSB-CP-LK	18-1/8 x 28 x 29	Legal width, compressors, locks	\$897	94

NOTE: Leveling glides may be added.

Simply add "-LG" suffix to item number and add **\$52** to list price.

HSB = high side with full integral pulls

'HF' hang frame files cabinets are non-standard.  
May be ordered as specials.

Call factory at 877.682.4601 for pricing.

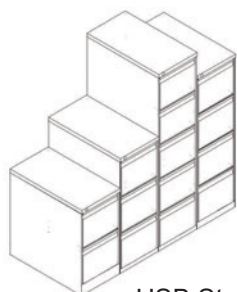

HSB Style Fronts

# Bentson Series 28" Deep

Ball Bearing Cradle Suspension / High Side Drawers



Catalog Number	Dimensions W x D x H	Description	List Price	Ship Weight
<b>Five drawer – 60-7/8" high with steel top</b>				
515HSA	15 x 28 x 60-7/8	Letter width, high side	\$1354	178
515HSA-LK	15 x 28 x 60-7/8	Letter width, locks	\$1437	180
545HSA	18-1/8 x 28 x 60-7/8	Legal width, high side	\$1467	195
545HSA-LK	18-1/8 x 28 x 60-7/8	Legal width, locks	\$1543	197
515HSA-CP	15 x 28 x 60-7/8	Letter width, compressors	\$1416	178
515HSA-CP-LK	15 x 28 x 60-7/8	Letter width, compressors, locks	\$1486	180
545HSA-CP	18-1/8 x 28 x 60-7/8	Legal width, compressors	\$1539	195
545HSA-CP-LK	18-1/8 x 28 x 60-7/8	Legal width, compressors, locks	\$1606	197



<b>Four drawer – 52" high with steel top</b>				
514HSA	15 x 28 x 52	Letter width, high side	\$1099	150
514HSA-LK	15 x 28 x 52	Letter width, locks	\$1178	152
544HSA	18-1/8 x 28 x 52	Legal width, high side	\$1193	162
544HSA-LK	18-1/8 x 28 x 52	Legal width, locks	\$1268	164
514HSA-CP	15 x 28 x 52	Letter width, compressors	\$1121	150
514HSA-CP-LK	15 x 28 x 52	Letter width, compressors, locks	\$1221	152
544HSA-CP	18-1/8 x 28 x 52	Legal width, compressors	\$1253	162
544HSA-CP-LK	18-1/8 x 28 x 52	Legal width, compressors, locks	\$1321	164

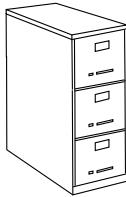

<b>Three drawer – 39-7/8" high with steel top</b>				
513HSA	15 x 28 x 39-7/8	Letter width, high side	\$955	115
513HSA-LK	15 x 28 x 39-7/8	Letter width, locks	\$1039	117
543HSA	18-1/8 x 28 x 39-7/8	Legal width, high side	\$1079	126
543HSA-LK	18-1/8 x 28 x 39-7/8	Legal width, locks	\$1106	128
513HSA-CP	15 x 28 x 39-7/8	Letter width, compressors	\$999	115
513HSA-CP-LK	15 x 28 x 39-7/8	Letter width, compressors, locks	\$1077	117
543HSA-CP	18-1/8 x 28 x 39-7/8	Legal width, compressors	\$1115	126
543HSA-CP-LK	18-1/8 x 28 x 39-7/8	Legal width, compressors, locks	\$1148	128

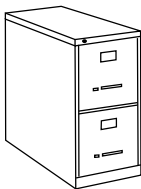

<b>Two drawer – 29" high with steel top</b>				
512HSA	15 x 28 x 29	Letter width, high side	\$695	86
512HSA-LK	15 x 28 x 29	Letter width, locks	\$768	88
542HSA	18-1/8 x 28 x 29	Legal width, high side	\$766	92
542HSA-LK	18-1/8 x 28 x 29	Legal width, locks	\$833	94
512HSA-CP	15 x 28 x 29	Letter width, compressors	\$717	86
512HSA-CP-LK	15 x 28 x 29	Letter width, compressors, locks	\$789	88
542HSA-CP	18-1/8 x 28 x 29	Legal width, compressors	\$784	92
542HSA-CP-LK	18-1/8 x 28 x 29	Legal width, compressors, locks	\$854	94

**NOTE:** The Bentson Series is also available in the HSB full integral pull style front. Call factory for pricing.

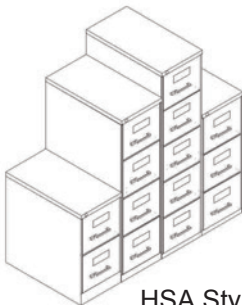

HSA Style Fronts

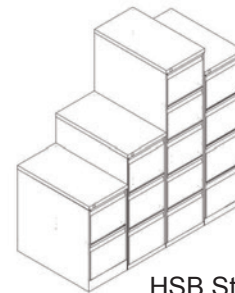

HSB Style Fronts

NOTE: Leveling glides may be added.

Simply add "-LG" suffix to item number and add **\$52** to list price.

'HF' hang frame files cabinets are non-standard. May be ordered as specials. Call factory at 877.682.4601 for pricing.

# Vertical Drawer Accessories

Top Laminate surface for  
28" deep  
vertical file cabinets.

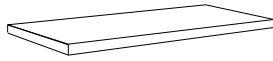

Catalog Number	Dimensions W x D	Description	List Price	Ship Weight
TL1528-SE	15 x 28	Wood core laminate top. Self-edge	\$146	25
TL1828-SE	18-1/8 x 28		\$171	29
TL1528-PV	15 x 28	Wood core laminate top. PVC edge	\$204	25
TL1828-PV	18-1/8 x 28		\$229	29

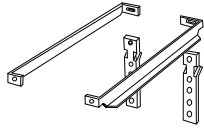

Field insertable for inside of  
lowside file drawers.

Catalog Number	Vertical Width	Description	List Price	Ship Weight
<b>Hanging folder frames for letter and legal width verticals for lowside drawers</b>				
HF-Vertical	Letter / Legal	One set hanging folder rails and frame Rail and frame for hanging folders For front to back filing.	\$73 per set / per drawer	
		Description	List Price	Ship Weight

## Accessories

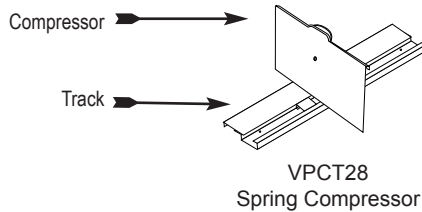

Spring Compressor & Track 28"	VPCT28	\$46	2.8 lbs. ea.
Spring Compressor (wo/Track)	L-62-DIP	\$36	.25

• These may be field installed.

**Note:** Compressor may be added at an upcharge if specified on order.

Catalog Number	Number of vertical drawers	Description	Factory Installed	Field Installed
<b>Plunger Style Replacement Lock Kits</b>				
<i>General locks and parts</i>				
LKV2	For 2 Drawer Vertical	Lock Kit		\$95
LKV3	For 3 Drawer Vertical	Lock Kit		\$95
LKV4	For 4 Drawer Vertical	Lock Kit		\$102
LKV5	For 5 Drawer Vertical	Lock Kit		\$102
264-N-V	Lock & Keys	Lock replacement with 2 keys [plunger style lock]		\$49
<b>Cylinder Locks &amp;/or Keys</b>				
264-N-RDU	Lock & Keys	Lock replacement with 2 keys [cylinder style lock]		\$39
264-N-D	Lock & Keys	Lock replacement with 2 keys [cylinder style lock]		\$39
EX-Keys	Extra Key	Extra Key – Identify key number stamped on lock.		\$10 net each

## Security Locks

SLB		Security lock bar. Welded to the outside of the file at the factory. Locked with a padlock (not included). Add SLB to file catalog number.	\$186	4
SPY		Security lock bar and floor pan. Welded to the outside of the file at the factory. Locked with a padlock (not included). Floor pan prevents access from bottom. Add SPY to file catalog number. Cannot be field installed.	\$271	7

Catalog Number	Number of vertical drawers	Description	Factory Installed	Field Installed
----------------	----------------------------	-------------	-------------------	-----------------

## Counter Weight For Verticals

CW2VF	For 2 Drawer Vertical	Counter Weight		\$153
CW3VF	For 3 Drawer Vertical	Counter Weight		\$164
CW4VF	For 4 Drawer Vertical	Counter Weight		\$176
CW5VF	For 5 Drawer Vertical	Counter Weight		\$189

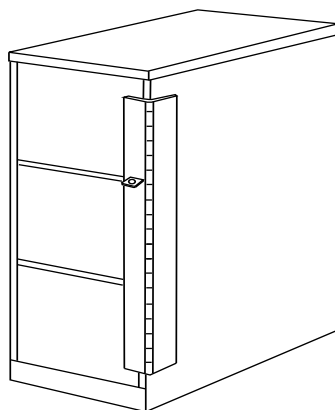

# C-Series Desk

---



## GENERAL PRODUCT INFORMATION

### Desks

- 29" high and have double or single pedestals.
- Back modesty panel is 3/4 height.
- Center drawer is standard in all desks and has a central locking system that locks all the desk pedestal drawers. Desks are keyed at random, unless otherwise specified.
- Square-faced drawer fronts with brushed aluminum pulls are standard.
- Optional full recessed (integral) pull drawer and file fronts available.
- Optional Pull-out (reference) posting shelves available.

### Pedestals

- Invincible™ Ultra Series pedestal design.
- Pedestals are letter width.
- Box drawers contain one adjustable steel divider. To order additional dividers, order part number DIV15.
- File drawers feature high sides for hanging folders. File drawer bottom are equipped to accept optional compressor with quick release lever. Ordered separately. They are Spring Compressor & Track 28", VPCT28.
- Drawers operate on ball bearing suspensions.

### Worksurfaces

- 1-1/4" thick high density wood core with high pressure laminate.
- T-Mold edge is standard.
- Corners are 1-5/8" radius. C-Series Desk with T-Mold edge is designed to match up to Invincible™'s Peninsula Break-away Table.
- Available in PVC or Waterfall top edge treatment.

### Legs/End Supports

- (4) prominent 1" heavy gauge steel chrome powder coat paint finish square legs.

# C-Series Desk

Double Pedestal	Catalog Number	Description	W	D	H	List Price	Ship Weight
	CD6030BB-TECDC	BB = Box/File on left & right	60"	30"	29"	\$1708	254
	CD6030AB-TECDC	AB = Box/Box/Box left, Box/File right	60"	30"	29"	\$1708	254

**NOTE:** Add " -PS "suffix for Pull-out (reference) Posting Shelves; add \$358 list for 2 shelves.

TE = T-Mold Edge

CDC = Central locking system when center drawer is locked.

Single Pedestal	Catalog Number	Description	W	D	H	List Price	Ship Weight
Substitute ** with BP or PB	CD7230**-TECDC		72"	30"	29"	\$1967	
	CD6630**-TECDC	BP = Box/File on left, Panel on right	66"	30"	29"	\$1909	
<b>NOTE:</b> Add " -PS "suffix for Pull-out (reference) Posting Shelf; add \$179 list for 1 shelf.	CD6030**-TECDC		60"	30"	29"	\$1852	
	CD4830**-TECDC	PB = Panel on left, Box/File on right	48"	30"	29"	\$1385	176
	CD4530**-TECDC		45"	30"	29"	\$1328	176

Return Single Ped	Catalog Number	Description	W	D	H	List Price	Ship Weight
	CLR4222B-TE	Left Return, Box/File Ped	42"	22"	29"	\$1554	
	CRR4222B-TE	Right Return, Box/File Ped	42"	22"	29"	\$1554	

C-Series Desks

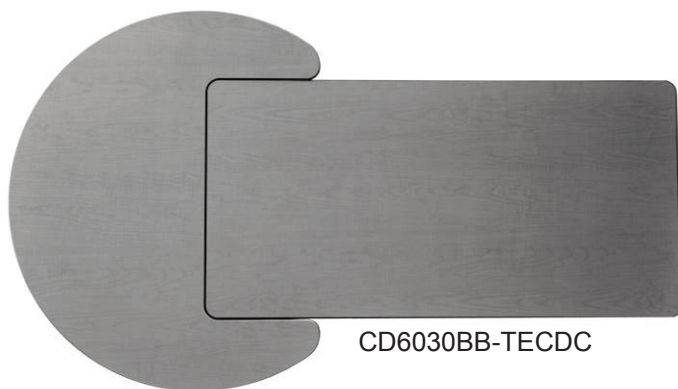

CD6030BB-TECDC

Illustrated here is the top view of our C-Series Desk, 60x30, Box/File on left, Box/File on right, T-Mold Edge, Central Locking System. It is matched up to our Peninsula Mobile Break-away Table.

See the table section for additional information on our Peninsula Breakaway Table.

**NOTE:** Compatible only in a Vinyl T-Mold Edge finish.

PBTM48-29

*Match form fit to any 30" deep desk with 1-5/8 radius corners.*

PBMT48-29



# Spirit Desk

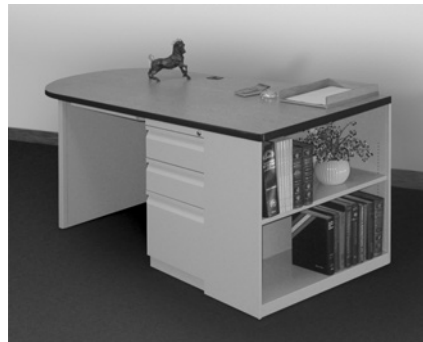

## GENERAL PRODUCT INFORMATION

Designed by teachers, for teachers. The Spirit Desk provides student conferencing, maximum storage and versatility with flexible design. The Spirit Desk is available with, or without, a bookcase or lateral. You have your choice of a variety of colors, sizes and configurations. Finally, a **“Teacher Friendly”** desk.

In today’s educational environment, it isn’t uncommon for a teacher to instruct out of different rooms. For the teacher on the go, Invincible™ now offers the Spirit Desk on casters making the work space completely mobile.

### Features:

- File drawers accommodate hanging files without additional hardware.
- Special sizes available.
- Adjustable leveling glides.
- T-edge molding.
- Adjustable shelf in bookcase.
- No sharp corners.
- Lifetime Warranty.
- Pedestal Locking
- Now available in a mobile unit.
- One grommet in top.
- Optional Locks may be keyed alike to other units.
- Full height modesty panel, with cable management.
- Ball bearing roller suspension.
- 1.25" thick work surface.
- Box drawers include one divider.
- Ships completely assembled.
- Optional center drawer or keyboard tray available.

### Codes:

T = Lateral  
K = Bookcase  
P = Panel End  
F = File / File Pedestal  
B = Box / Box / File Pedestal

# Spirit Desk

Top Dimensions	Bookcase	Catalog Number	Description	List Price	Ship Weight
<b>Single Pedestals</b>					
60 x 30 "D" Left	No	SD6030PF-TE	Panel left, FF right	\$1647	202
60 x 30 "D" Right	No	SD6030FP-TE	FF left, Panel right	\$1647	202
60 x 30 "D" Left	No	SD6030PB-TE	Panel left, BBF right	\$1681	202
60 x 30 "D" Right	No	SD6030BP-TE	BBF left, Panel right	\$1681	202

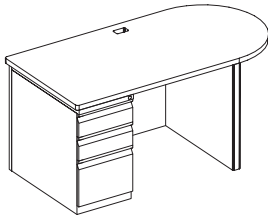

"D" Right  
SD6030BP

<b>Double Pedestals</b>					
72 x 30 "D" Left	No	SD7230FFL-TE	FF left & right	\$2125	220
72 x 30 "D" Right	No	SD7230FFR-TE	FF left & right	\$2125	220
72 x 30 "D" Left	No	SD7230BBL-TE	BBF left & right	\$2193	220
72 x 30 "D" Right	No	SD7230BBR-TE	BBF left & right	\$2193	220
72 x 30 "D" Left	No	SD7230FBL-TE	FF left & BBF right	\$2158	220
72 x 30 "D" Right	No	SD7230FBR-TE	FF left & BBF right	\$2158	220
72 x 30 "D" Left	No	SD7230BFL-TE	BBF left & FF right	\$2158	220
72 x 30 "D" Right	No	SD7230BFR-TE	BBF left & FF right	\$2158	220

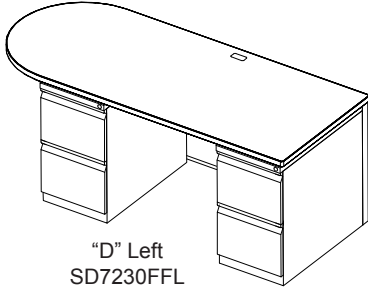

"D" Left  
SD7230FFL

<b>Bookcase and Single Pedestal</b>					
72 x 30 "D" Left	Yes	SD7230PFK-TE	Panel Left, FF & Bookcase right	\$1957	195
72 x 30 "D" Right	Yes	SD7230KFP-TE	FF & Bookcase left, Panel right	\$1957	195
72 x 30 "D" Left	Yes	SD7230PBK-TE	Panel left, BBF & Bookcase right	\$1990	195
72 x 30 "D" Right	Yes	SD7230KBP-TE	BBF & Bookcase left, Panel right	\$1990	195

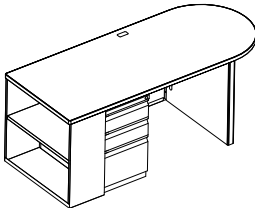

"D" Right  
SD7230KBP

<b>Bookcase and Double Pedestal</b>					
72 x 30 "D" *L or R	Yes	SD7230FFK*-TE	Bookcase center, FF left & right	\$2313	245
72 x 30 "D" *L or R	Yes	SD7230BFK*-TE	Bookcase center, BBF left & FF right	\$2343	245
72 x 30 "D" *L or R	Yes	SD7230BBK*-TE	Bookcase center, BBF left & right	\$2357	245

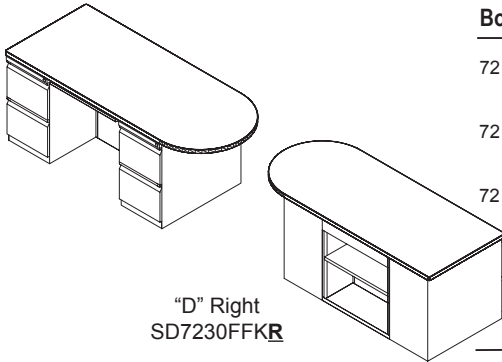

"D" Right  
SD7230FFKR

NOTE: Center drawer may be added.  
See page 21 for center drawer options.

<b>Lateral and Single Pedestal</b>					
60 x 30 No "D" Top	No	SD6030BT-2S-TE	BBF right, Lateral right	\$1985	239
60 x 30 No "D" Top	No	SD6030TB-2S-TE	Lateral left, BBF right	\$1985	239
72 x 30 "D" Left	No	SD7230BTL-2S-TE	BBF left, Lateral right D left	\$2193	220
72 x 30 "D" Right	No	SD7230TBR-2S-TE	Lateral left, BBF right D right	\$2193	220

NOTE: Posting shelves may be added.

Single pedestal add \$179 Add "-PSL" or "-PSR" [left & right] suffix to item number  
Double pedestal add \$358 Add "-PS" suffix to item number



# Mobile Spirit Desk



"D" Right  
SDM6030BP

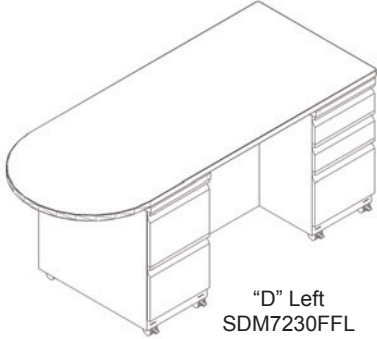

"D" Left  
SDM7230FFL

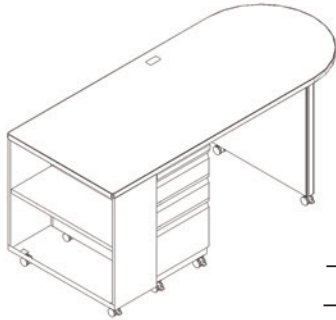

"D" Right  
SDM7230KBP

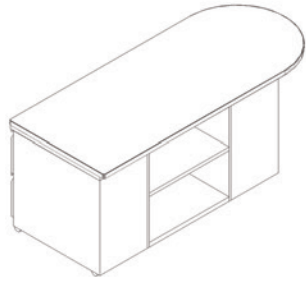

"D" Right  
SDM7230FFKR

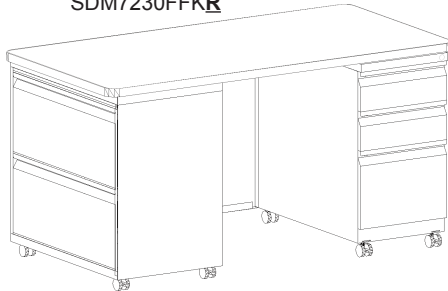

Top Dimensions	Bookcase	Catalog Number	Description	List Price	Ship Weight
<b>Mobile Single Pedestals</b>					
60 x 30 "D" Left	No	SDM6030PF-TE	Panel left, FF right	\$1828	206
60 x 30 "D" Right	No	SDM6030FP-TE	FF left, Panel right	\$1828	206
60 x 30 "D" Left	No	SDM6030PB-TE	Panel left, BBF right	\$1862	206
60 x 30 "D" Right	No	SDM6030BP-TE	BBF left, Panel right	\$1862	206
<b>Mobile Double Pedestals</b>					
72 x 30 "D" Left	No	SDM7230FFL-TE	FF left & right	\$2306	224
72 x 30 "D" Right	No	SDM7230FFR-TE	FF left & right	\$2306	224
72 x 30 "D" Left	No	SDM7230BBL-TE	BBF left & right	\$2374	224
72 x 30 "D" Right	No	SDM7230BBR-TE	BBF left & right	\$2374	224
72 x 30 "D" Left	No	SDM7230FBL-TE	FF left & BBF right	\$2340	224
72 x 30 "D" Right	No	SDM7230FBR-TE	FF left & BBF right	\$2340	224
72 x 30 "D" Left	No	SDM7230BFL-TE	BBF left & FF right	\$2340	224
72 x 30 "D" Right	No	SDM7230BFR-TE	BBF left & FF right	\$2340	224
<b>Mobile Bookcase and Single Pedestal</b>					
72 x 30 "D" Left	Yes	SDM7230PFK-TE	Panel left, FF & Bookcase right	\$2138	199
72 x 30 "D" Right	Yes	SDM7230KFP-TE	FF & Bookcase left, Panel right	\$2138	199
72 x 30 "D" Left	Yes	SDM7230PBK-TE	Panel left, BBF & Bookcase right	\$2171	199
72 x 30 "D" Right	Yes	SDM7230KBP-TE	BBF & Bookcase left, Panel right	\$2171	199

NOTE: Center drawer may be added.  
See page 21 for center drawer options.

Desks  
Spirit

NOTE: Posting shelves may be added.

Single pedestal add \$179 Add "-PSL" or "-PSR" [left & right] suffix to item number

Double pedestal add \$358 Add "-PS" suffix to item number





# Cube & Contemporary Desks

---



Cube Desk



Contemporary Desk

## GENERAL PRODUCT INFORMATION

### Desks

- 29" high and have double or single pedestals.
- Standard back modesty panel is 3/4 height on Contemporary Desks. Back panels on Cube Desks are available in X back, 3/4 height and full height.
- Seamless back and sides with full height flush end panels on contemporary style.
- Seamed flush modesty on cube.
- End panel and legs have non-corrosive adjustable floor glides.
- Optional non-locking center drawer operates on ball bearing suspensions.

### Pedestals

- Box/File pedestal units (left and right) contain their own lock. All pedestals are letter width. (Locks are randomly keyed unless otherwise specified.) May be keyed alike to other units.
- Box drawers contain one adjustable steel divider. To order additional dividers, order part number DIV15.
- File drawers feature high sides for hanging folders. File drawer bottom are equipped to accept optional compressor with quick release lever. Order Spring Compressor & Track 28", VPCT28.
- Drawers operate on ball bearing suspensions.

### Worksurfaces

- CONTEMPORARY: 1-1/4" thick high density wood core with high pressure laminate. Rounded waterfall edge front and back (except L-returns and bridge unit which are rounded front only on working side of desk, valley filler included). Worksurfaces include grommet in Desks & Credenzas. Please specify if no grommet is required. No grommet included in Bridges or Returns.
- CUBE: 1-1/4" thick high density wood core with high pressure laminate and PVC edge band sides (corners are square). Worksurfaces include grommet on Desks. Please specify if no grommet is required. No grommet on Returns, Bridges or Credenzas.

### Legs/End Supports

- CONTEMPORARY: End supports are constructed of sturdy steel (1" thick) with reinforced stiffeners flush with desk front and back and finished ends extending to floor.

# Cube Series Desks & Returns

## Double Pedestal - Without Center Drawer

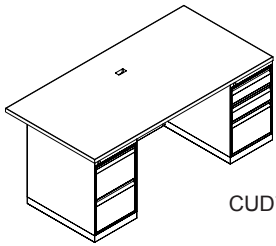

CUD7236FB

Catalog Number	W	D	H	List Price	Ship Weight
CUD7236 <sup>^</sup> •-PV	72"	36"	29"	\$1870	300
CUD7230 <sup>^</sup> •-PV	72"	30"	29"	\$1778	285
CUD6630 <sup>^</sup> •-PV	66"	30"	29"	\$1676	280
CUD6030 <sup>^</sup> •-PV	60"	30"	29"	\$1572	270

## Single Pedestal - Without Center Drawer

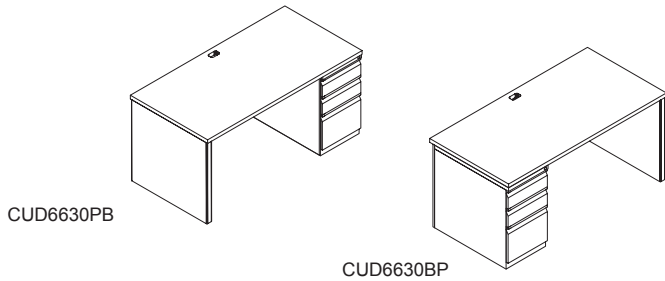

CUD6630PB

CUD6630BP

Catalog Number	W	D	H	List Price	Ship Weight
CUD7236 <sup>^</sup> •P-PV	72"	36"	29"	\$1758	266
CUD7236 <sup>^</sup> P•-PV	66"	36"	29"	\$1758	266
CUD6636 <sup>^</sup> •P-PV	66"	36"	29"	\$1704	249
CUD6636 <sup>^</sup> P•-PV	66"	36"	29"	\$1704	249
CUD7230 <sup>^</sup> •P-PV	72"	30"	29"	\$1562	260
CUD7230 <sup>^</sup> P•-PV	72"	30"	29"	\$1562	260
CUD6630 <sup>^</sup> •P-PV	66"	30"	29"	\$1420	240
CUD6630 <sup>^</sup> P•-PV	66"	30"	29"	\$1420	240
CUD6030 <sup>^</sup> •P-PV	60"	30"	29"	\$1388	225
CUD6030 <sup>^</sup> P•-PV	60"	30"	29"	\$1388	225
CUD4830 <sup>^</sup> •P-PV	48"	30"	29"	\$1356	190
CUD4830 <sup>^</sup> P•-PV	48"	30"	29"	\$1356	190
CUD4530 <sup>^</sup> •P-PV	45"	30"	29"	\$1239	190
CUD4530 <sup>^</sup> P•-PV	45"	30"	29"	\$1239	190

## Pedestal Options

Replace suffix • with: B = Box/Box/File or F = File/File

Example: CUD6030BF-TE = (Box/Box/File on left & File/File on right)

**Specify back panel in lieu of carat (^) symbol.**

F = Full Height Back Panel [standard]

H = 3/4 Height 21-1/2" Back Panel \*

X = Wall Access Open Frame Back Panel \*

\* No upcharge for H or X back panels.

**NOTE:** Posting shelves may be added.

Single pedestal add \$179 Add "-PSL" or "-PSR" [left & right] suffix to item number

Double pedestal add \$358 Add "-PS" suffix to item number

## Returns - Desk Height Only (Includes Mounting Hardware)

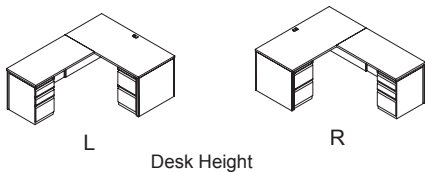

Desk Height

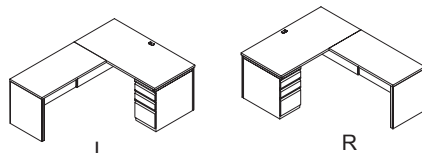

**PLEASE SPECIFY:**

### Box/Box/File Ped - w/Lock

CU*R4222 <sup>^</sup> B-PV	45"	22-1/2"	29"	\$1126	143
CU*R4224 <sup>^</sup> B-PV	45"	22-1/2"	29"	\$1126	146
CU*R4522 <sup>^</sup> B-PV	45"	22-1/2"	29"	\$1146	149
CU*R4824 <sup>^</sup> B-PV	48"	24"	29"	\$1276	149

### File/File Ped - w/Lock

CU*R4222 <sup>^</sup> F-PV	45"	22-1/2"	29"	\$1048	143
CU*R4224 <sup>^</sup> F-PV	45"	22-1/2"	29"	\$1048	146
CU*R4522 <sup>^</sup> F-PV	45"	22-1/2"	29"	\$1067	149
CU*R4824 <sup>^</sup> F-PV	48"	24"	29"	\$1197	149

### No Pedestal

CU*R4522 <sup>^</sup> P-PV	45"	22-1/2"	29"	\$658	98
CU*R4824 <sup>^</sup> P-PV	48"	24"	29"	\$789	98

\* specify L or R for Left or Right where an asterisk is denoted

Please specify Paint Color, Laminate and Edge Treatment choice.

Desks  
Cube

# Cube Series

Cube Credenza- Double Ped	Catalog Number	W	D	H	List Price	Ship Weight
---------------------------	----------------	---	---	---	------------	-------------

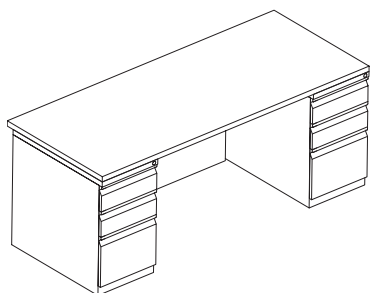

CUC6024BB

### Pedestal Options

Replace suffix • with:

B = Box/Box/File

F = File/File

P = Panel [ no ped ]

CUC7224^••-PV	72"	24"	29"	\$1519	280
CUC6624^••-PV	66"	24"	29"	\$1414	275
CUC6024^••-PV	60"	24"	29"	\$1343	270

1-GRR Grommet Option (Specify Location) \$57

Cube Credenza- Single Ped	Catalog Number	W	D	H	List Price
---------------------------	----------------	---	---	---	------------

CUC7224^PF-PV	72"	24"	29"	\$1427
CUC7224^FP-PV	72"	24"	29"	\$1427
CUC6624^PF-PV	66"	24"	29"	\$1322
CUC6624^FP-PV	66"	24"	29"	\$1322
CUC6024^PF-PV	60"	24"	29"	\$1250
CUC6024^FP-PV	60"	24"	29"	\$1250
CUC6024^PB-PV	60"	24"	29"	\$1250
CUC6024^BP-PV	60"	24"	29"	\$1250

### Specify back panel in lieu of carat (^) symbol.

F = Full Height Back Panel [standard]

H = 3/4 Height 21-1/2" Back Panel \*

X = Wall Access Open Frame Back Panel \*

\* No upcharge for H or X back panels.

Bridge (Includes Mounting Hardware)	Catalog Number	W	D	List Price	Ship Weight
-------------------------------------	----------------	---	---	------------	-------------

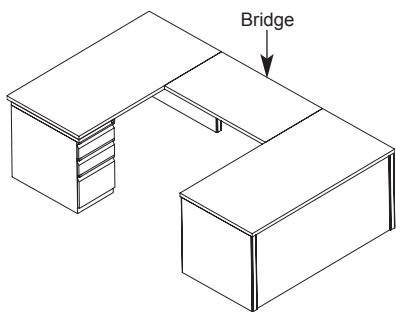

CUB3622-PV	36"	22-1/2"	\$523	72
CUB4222-PV	42"	22-1/2"	\$561	83
CUB4822-PV	48"	22-1/2"	\$601	94
CUB3624-PV	36"	24"	\$569	74
CUB4224-PV	42"	24"	\$581	86
CUB4824-PV	48"	24"	\$665	105

Center Drawer	Catalog Number	Dimensions	Description	List Price	Ship Weight
---------------	----------------	------------	-------------	------------	-------------

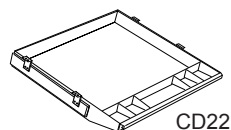

CD22

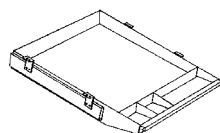

CD18

CD22	20 3/4" x 22-3/8"	2" deep center drawer mounts under worksurface. 5 front compartments. No lock.	\$178	13
CD18	15" x 22-3/8"	Same as above with 3 front compartments.	\$174	11
CD15	12" x 11 3/4"	2" deep center drawer mounts under work-surface with 1 side to side compartment	\$122	8
UPT115		Pencil Tray	\$58	.5
408-YY		Suspension for Center Drawer	\$18	

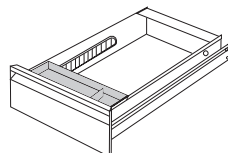

UPT115

### Center Drawer Lock

LK	Lock Option	\$39
----	-------------	------

Order Example:CD22LK \$217

Desks  
Cube

# Contemporary Series Desks & Returns

Double Pedestal - Without Center Drawer		Catalog Number	W	D	H	List Price	Ship Weight
		COD7236BB-WF	72"	36"	29"	\$1871	278 With 6" overhang
		COD6630BB-WF	66"	30"	29"	\$1705	260
		COD6030BB-WF	60"	30"	29"	\$1572	250
		COD6030AA-WF	60"	30"	29"	\$1572	250
		Drawer Depth 22"	BB = Box/File		AA = Box/Box/Box		

Single Pedestal - Without Center Drawer		Catalog Number	W	D	H	List Price	Ship Weight
<p>(PB)</p> <p>(BP)</p>		COD7236BP-WF	72"	36"	29"	\$1547	224
		COD7236PB-WF	72"	36"	29"	\$1547	224 With 6" overhang
		COD7230BP-WF	72"	30"	29"	\$1478	224
		COD7230PB-WF	72"	30"	29"	\$1478	224
		COD6630BP-WF	66"	30"	29"	\$1420	224
		COD6630PB-WF	66"	30"	29"	\$1420	224
		COD6030BP-WF	60"	30"	29"	\$1388	208
		COD6030PB-WF	60"	30"	29"	\$1388	208
		COD4830BP-WF	48"	30"	29"	\$1279	184
		COD4830PB-WF	48"	30"	29"	\$1279	184
	COD4530BP-WF	45"	30"	29"	\$1238	174	
	COD4530PB-WF	45"	30"	29"	\$1238	174	
		Drawer Depth 22"					

**NOTE:** B = Box/File drawer configuration  
P = End Panel

BP = Box/File on left, End Panel on right.  
Respectively a PB = End Panel on left, Box/File on right.

Returns are affixed to the panel side. Therefore a BP will use a right return and a PB will use a left return.

**NOTE:** Posting shelves may be added.

Single pedestal add \$179 Add "-PSL" or "-PSR" [left & right] suffix to item number

Double pedestal add \$358 Add "-PS" suffix to item number

## Returns (Includes Mounting Hardware)

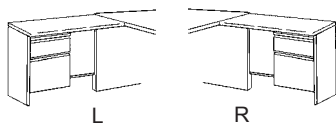

Desk Height

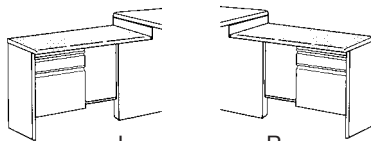

Machine Height

### Box/File Ped 29" Desk Height

CO*R4522B-WF	45" 22-1/2" 29"	\$1067	138
CO*R4822B-WF	48" 22-1/2" 29"	\$1164	138

VF- Valley Filler (metal) included

### Box/File Ped 26" Keyboard Height

CO*R452226B-WF (left return)	45" 22-1/2" 26"	\$1067	138
------------------------------	-----------------	--------	-----

Grommet Option (Specify Location) \$57

## PLEASE SPECIFY:

\* specify L or R for Left or Right where an asterisk is denoted

Please specify Paint Color and Laminate preference.

Center drawer is optional and drawer depth is 22".

# Contemporary Series Credenzas, Bridges & Drawers

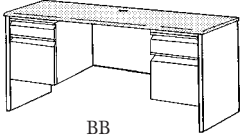
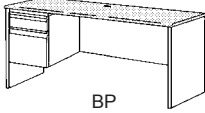
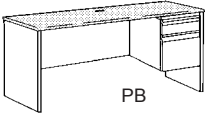
Credenzas without Center Drawer	Catalog Number	W	D	H	List Price	Ship Weight
 <p>BB</p>	COC7224BB-WF	72"	22-1/2"	29"	\$1624	220
	COC6624BB-WF	66"	22-1/2"	29"	\$1605	220
	COC6024BB-WF	60"	22-1/2"	29"	\$1581	220
 <p>BP</p>	COC7224BP-WF	72"	22-1/2"	29"	\$1420	192
	COC7224PB-WF	72"	22-1/2"	29"	\$1420	192
 <p>PB</p>	COC6624BP-WF	66"	22-1/2"	29"	\$1391	184
	COC6624PB-WF	66"	22-1/2"	29"	\$1391	184
	Grommet Option (Specify Location)				\$56	

Drawer Depth 22"

## Credenzas with a Center Cupboard

COC6024BCB-WF	60"	22-1/2"	29"	\$2216	390	
Center Cabinet with Full Pull Doors						
COC6024BSB-WF	60"	22-1/2"	29"	\$2216	390	
Center Cabinet with Sliding Doors						

## Bridge (Includes Mounting Hardware)

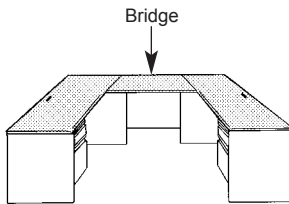

Bridge (Includes Mounting Hardware)	Catalog Number	W	D	H	List Price	Ship Weight
	COB4222-WF	42"	22-1/2"	29"	\$561	76
	COB4822-WF	48"	22-1/2"	29"	\$601	82
VF- Valley Filler (metal) included						

## Center Drawer

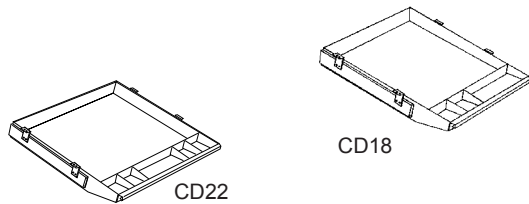

Center Drawer	Catalog Number	W	D	List Price	Ship Weight
	CD22	20 3/4"	x 22-3/8"	\$178	13
	CD18	15"	x 22-3/8"	\$174	11
	CD15	12"	x 11 3/4"	\$122	8
	UPT115	Pencil Tray		\$50	.5
	408-YY	Suspension for Center Drawer		\$18	

## Center Drawer Lock

LK	Lock Option	\$39
Order Example: CD22LK		\$217

# M-Line Desks



## GENERAL PRODUCT INFORMATION

### **M-Line Desks**

- M-Line desks are 29-5/8" high and have double or single pedestals.
- TE wood core laminate tops with vinyl T-edge molding are standard. TF steel core laminate tops with stainless steel binding and powder coat painted rim are **available as an option**.
- Each pedestal has a slide out reference posting shelf 13-5/8" wide x 16-1/4" deep.
- The center drawer is standard in all desks and has a central locking system that locks all the desk pedestal drawers. Desks are keyed at random, unless otherwise specified.
- Pedestals are letter width.
- Single pedestal desks must be 60" or wider to accept a return.

### **Desk Worksurfaces**

- Prefix TE indicates vinyl T-edge laminate, wood core construction with rounded corners. Prefix TF (**available as an option**) indicates laminate top, steel core with "W" stiffener construction, stainless steel edge binding with powder coat painted rim and rounded corners.

### **Suspension System**

- Desk box drawers operate on rounded edge nylon glides. Desk file drawers have 5-member cradle suspension with four (4) nylon rollers and six (6) nylon tired steel ball bearing rollers giving full drawer extension.
- All 18" depth pedestal drawers have 3-member progressive ball bearing suspension, giving full drawer extension.

### **M-Line File Drawers**

- Front to back hanging folder rails are standard.
- A compressor may be substituted with an upcharge if specified at time of order.

### **M-Line Box Drawers**

- Desk pedestal box drawers are letter width having one cross divider as standard.
- 18" depth pedestal drawers offer letter or legal width filing, having one cross divider as standard.

### **Pencil Tray**

- One desk box drawer provided with a pencil tray when center drawer is omitted—Pedestal Non-locking.

# M-Line Double & Single Pedestal Desks

Catalog Number	Dimensions W x D x H	Description	List Price	Ship Weight
----------------	-------------------------	-------------	------------	-------------

## Double Pedestal Desks (wood Core Top)

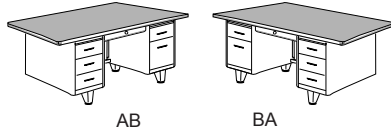

MD7236AB-TE	72 x 36 x 29	A = Box/Box/Box left & B = Box/File right Top 6-1/2" overhang on each side & back	\$2474	317
MD7236BA-TE	72 x 36 x 29	B = Box/File left & A = Box/Box/Box right Top 6-1/2" overhang on each side & back	\$2474	317
MD7236AA-TE	72 x 36 x 29	A = Box/Box/Box left & right Top 6-1/2" overhang on each side & back	\$2474	325
MD7236BB-TE	72 x 36 x 29	B = Box/File left & right Top 6-1/2" overhang on each side & back	\$2474	310

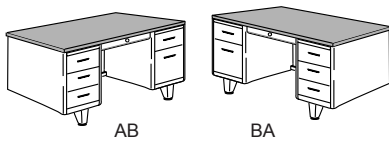

MD6036AB-TE	60 x 36 x 29	A = Box/Box/Box left & B = Box/File right No overhang	\$2297	263
MD6036BA-TE	60 x 36 x 29	B = Box/File left & A = Box/Box/Box right No overhang	\$2297	263
MD6036AA-TE	60 x 36 x 29	A = Box/Box/Box left & right No overhang	\$2297	271
MD6036BB-TE	60 x 36 x 29	B = Box/File left & right No overhang	\$2297	255

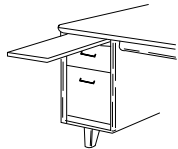

Reference shelf included above each pedestal

MD6030AB-TE	60 x 30 x 29	A = Box/Box/Box left & B = Box/File right No overhang	\$2127	263
MD6030BA-TE	60 x 30 x 29	B = Box/File left & A = Box/Box/Box right No overhang	\$2127	263
MD6030AA-TE	60 x 30 x 29	A = Box/Box/Box left & right No overhang	\$2127	271
MD6030BB-TE	60 x 30 x 29	B = Box/File left & right No overhang	\$2127	255

## Single Pedestal Desks (Wood Core Top)

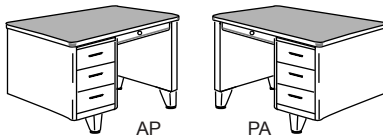

MD4530AP-TE	45 x 30 x 29	A = Box/Box/Box left, P = Panel End right	\$1765	194
MD4530PA-TE	45 x 30 x 29	P = Panel End left, A = Box/Box/Box right No overhang	\$1765	194

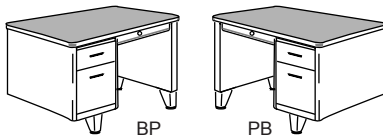

MD4530BP-TE	45 x 30 x 29	B = Box/File left, P = Panel End right	\$1765	194
MD4530PB-TE	45 x 30 x 29	P = Panel End left, B = Box/File right No overhang	\$1765	194

## Steel Core Tops

TF	For steel core top with stainless steel rim (binding), substitute -TF in place of -TE in part number. Factory installed only.	\$298
----	--	-------

# M-Line Single Pedestal Desks & Returns

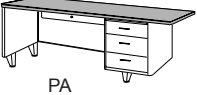
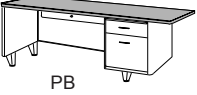
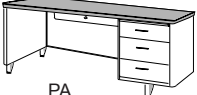
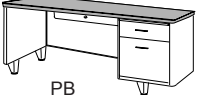
Catalog Number	Dimensions W x D x H	Description	List Price	Ship Weight
<b>Right-Left Sided Pedestal ( Wood Core Top)</b>				
 PA		MD7230PA <sup>•</sup> -TE (*R/C) 72 x 30 x 29	3 box right 12" overhang; select right or center	\$2157 264
 PB		MD7230PB <sup>•</sup> -TE (*R/C) 72 x 30 x 29	Box/file right 12" overhang; select right or center	\$2157 264
 PA		MD6030PA-TE 60 x 30 x 29	3 box right No overhang	\$2032 230
 PB		MD6030PB-TE 60 x 30 x 29	Box/file right No overhang	\$2032 230

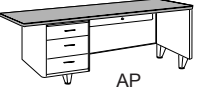
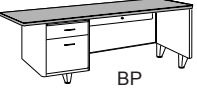
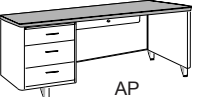
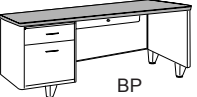
Catalog Number	Dimensions W x D x H	Description	List Price	Ship Weight
<b>Left-Right Sided Single Pedestal (Wood Core Top)</b>				
 AP		MD7230AP <sup>•</sup> -TE (*L/C) 72 x 30 x 29	3 box left 12" overhang; select left or center	\$2157 264
 BP		MD7230BP <sup>•</sup> (*L/C) 72 x 30 x 29	Box/file left 12" overhang; select left or center	\$2157 264
 AP		MD6030AP-TE 60 x 30 x 29	3 box left No overhang	\$2032 230
 BP		MD6030BP-TE 60 x 30 x 29	Box/file left No overhang	\$2032 230

Catalog Number	Dimensions W x D x H	W x D	List Price	Ship Weight
<b>Left and Right – Desk height with pedestal</b>				
		Box/box/file		
M <sup>•</sup> R3620B-TE	36 x 22-1/2 x 29	15 x 18	\$1773	110
M <sup>•</sup> R4620B-TE	46-1/2 x 22-1/2 x 29	15 x 18	\$1830	121

\*Substitute L or R for left or right return



Catalog Number	Dimensions W x D x H	W x D	List Price	Ship Weight
<b>Left and Right – Desk height with locking pedestal</b>				
		Box/box/file		
M <sup>•</sup> R3620B-LK-TE	36 x 22-1/2 x 29	15 x 18	\$1882	110
M <sup>•</sup> R4620B-LK-TE	46-1/2 x 22-1/2 x 29	15 x 18	\$1879	121

\*Substitute L or R for left or right return

Returns with pedestals do not include modesty panel.

Catalog Number	Description	List Price
<b>Steel Core Tops</b>		
TF	For steel core top with stainless steel rim (binding), substitute -TF in place of -TE in part number. Factory installed only.	\$298



# M-Line Credenzas



Catalog Number	Dimensions W x D x H	Description	List Price	Ship Weight
MC7922-TE*	67-3/4 x 22-1/2 x 29	One cupboard with steel sliding doors. No shelf included. Two pedestals 22-3/32" deep with one file drawer and two two box drawers each.	\$3332	272
MS7922-TE*		M-Line Shelf	\$97	

**\*Special Order Only - Extended Lead Time**



MC6122-TE	61-1/2 x 22-1/2 x 29	Two letter width pedestals 22-3/32" deep with one file drawer and two box drawers. Includes full back panel and center space opening.	\$2285	194
-----------	----------------------	--	--------	-----



MC6422-TE	61-1/2 x 22-1/2 x 29	Four letter width pedestals 22-3/32" deep with one file drawer and two box drawers each.	\$3518	338
-----------	----------------------	--	--------	-----

NOTE: Credenza tops have 3/4" overhang on each end minimum. (TE or TF style.)

## Steel Core Tops

TF	For steel core top with stainless steel rim (binding), substitute -TF in place of -TE in part number. Factory installed only.	\$298
----	---	-------

## Lock

Add charge for lock per cabinet. Add suffix LK to part number prior to edge treatment reference.

Factory installed only. \$49

**Example:** MC6420LK-TE

# Tables



VISTA Training Tables



Peninsula Mobile Break-away Table



Contemporary Boat Table

## GENERAL PRODUCT INFORMATION

### Access Series Computer Tables Feature

- Rear access lockable channel offering high end security from would be vandals
- Come standard with two (2) grommets.
- 54" and wider tables come standard with two (2) top grommets.
- Fixed C-Legs with pass through Wire Management.
- Optional Shared Leg for table runs.
- Vinyl T-Mold edge standard.
- Powder coat painted C-Legs standard.

### Elevation Series Feature

- Elevation Series tables/desks provide the ultimate in versatility.
- Tables are height-adjustable from 28-1/2" to 41-3/4".
- When equipped with a box/file pedestal and casters the adjustable-height table serves as a great mobile desk!
- Available with or without locking box/file pedestal
- Available with optional electrical pop-up and wiring channel
- Available with adjustable leveling glides and with casters
- Vinyl T-mold edge standard.
- Powder coat painted C-Legs standard.

### Drafting Series Feature

- Invincible™ drafting tables feature a tilt-top drafting surface that can be adjusted from flat to 45 degrees. Tilt adjustment mechanisms allow you to position the top where you want it.
- Tables are available in 36", 42", 48" and 60" widths.
- Tables up to 48" feature a single tilt-adjustable top.
- The 60" table features a split-top, with a 36" tilt top on the left, with a 24" fixed top on the right.
- Tables may be ordered with adjustable leveling glides, or with casters.
- PVC edge standard.
- Powder coat painted C-Legs standard.

### VISTA Training Tables Feature

Refer to page 55.

### Liberty Series Feature

- 6" deep by 4" wide Laminate Flip door Cable Management Channel.
- Fixed C-Legs with pass through Wire Management.
- Optional Shared Leg for table runs.
- PVC edge standard.
- Powder coat painted C-Legs standard.

### Contemporary Series Feature

- Powder Coat painted legs standard. Chrome powder coat painted legs available.
- Mirror chrome legs available. Call factory for pricing as upcharge applies. For mirror chrome base legs, the "P" in the part number would become "C".
- Laminate tops are available with self-edge or vinyl T-mold edge. Call factory for pricing on self-edge Racetrack Tables.
- Tables are available in various sizes and shapes. Consult factory for special sizes and pricing.

### Peninsula Break-away Series Feature

- Vinyl T-Mold edged laminate top.
- Powder Coat painted legs standard.
- Match form fit to all desks having 1-5/8" radius corners.
- Mobile; uses standard 2" wheels.
- May be matched to mobile or standard height desks.

### S – Series Tables Feature

- Self edged laminate top.
- Removable, 1" square painted legs standard.
- Mirror chrome legs available. Consult factory for special pricing.

### R – Series Tables Feature

- PVC edged laminate top.
- Round painted legs.

### Freedom Series Feature

- Folding or Fixed Leg option.
- 30" and 24" deep surfaces available.
- 6" Laminate Modesty Panel option available.
- PVC edge standard.
- Powder Coat painted T-Legs standard.
- Optional Grommets in top- Consult Factory.

# Tables

## Access Series Computer Tables

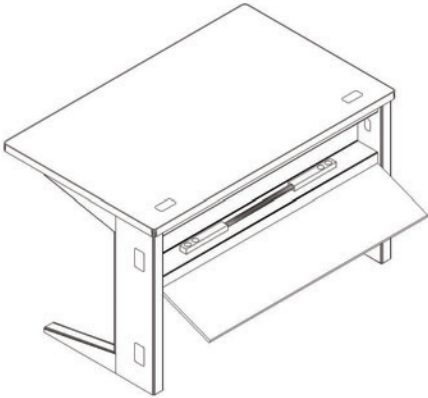
	Catalog Number	Dimensions W x D x H	Description	List Price
<b>24" Deep Computer Table with Locking Rear Access Panel</b>				
	ACT3024A-LK-TE	30x24x29	Access Series <b>POWERED</b> computer table,	\$1043
	ACT3624A-LK-TE	36x24x29	locking rear panel, C-Leg, T-Mold Edge.	\$1063
	ACT4224A-LK-TE	42x24x29		\$1090
	ACT4824A-LK-TE	48x24x29		\$1112
	ACT5424A-LK-TE	54x24x29		\$1144
	ACT6024A-LK-TE	60x24x29		\$1178
	ACT7224A-LK-TE	72x24x29		\$1326
	ACT3024LK-TE	30x24x29	Access Series <b>NON-POWERED</b> computer	\$924
	ACT3624LK-TE	36x24x29	table, locking rear panel, C-Leg, T-Mold Edge.	\$944
	ACT4224LK-TE	42x24x29		\$971
	ACT4824LK-TE	48x24x29		\$993
	ACT5424LK-TE	54x24x29		\$1025
	ACT6024LK-TE	60x24x29		\$1059
	ACT7224LK-TE	72x24x29		\$1208
Catalog Number	Dimensions W x D x H	Description	List Price	

## 30" Deep Computer Table with Locking Rear Access Panel

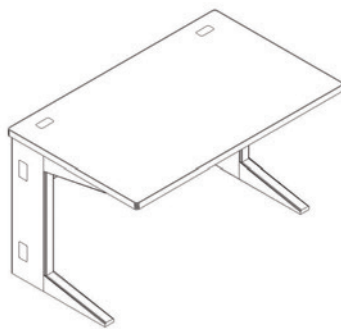

ACT3030A-LK-TE	30x30x29	Access Series <b>POWERED</b> computer table,	\$1078
ACT3630A-LK-TE	36x30x29	locking rear panel, C-Leg, T-Mold Edge.	\$1108
ACT4230A-LK-TE	42x30x29		\$1128
ACT4830A-LK-TE	48x30x29		\$1161
ACT5430A-LK-TE	54x30x29		\$1209
ACT6030A-LK-TE	60x30x29		\$1243
ACT7230A-LK-TE	72x30x29		\$1384
ACT3030LK-TE	30x30x29	Access Series <b>NON-POWERED</b> computer	\$959
ACT3630LK-TE	36x30x29	table, locking rear panel, C-Leg, T-Mold Edge.	\$989
ACT4230LK-TE	42x30x29		\$1009
ACT4830LK-TE	48x30x29		\$1043
ACT5430LK-TE	54x30x29		\$1090
ACT6030LK-TE	60x30x29		\$1124
ACT7230LK-TE	72x30x29		\$1265

## Liberty Tables

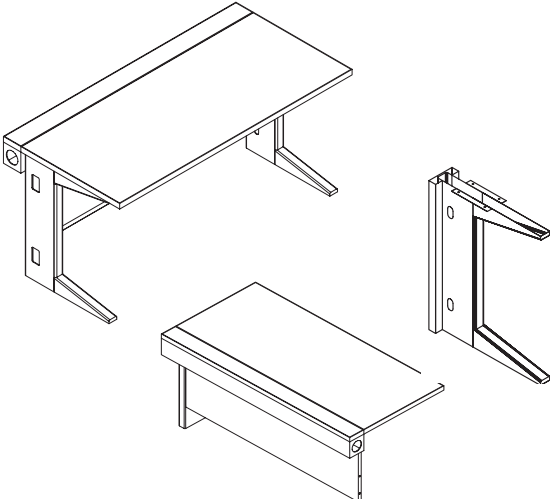
	Catalog Number	Dimensions W x D x H	Description	List Price	
<b>Computer / Lab Table</b>					
	LT3630-PV	36 x 30 x 29		\$1024	
	LT4230-PV	42 x 30 x 29	Table has PVC edge with a flat flip top	\$1099	
	LT4830-PV	48 x 30 x 29	cord manager box on back side of table	\$1194	
	LT5430-PV	54 x 30 x 29	end of cord box. Ships knocked down	\$1289	
	LT6030-PV	60 x 30 x 29	with two legs	\$1388	
	LT6630-PV	66 x 30 x 29		\$1482	
	LT7230-PV	72 x 30 x 29		\$1581	
	<b>SCL29 to be used to attach two or more tables</b>			Shared C-Leg SCL29	\$227
	LT3630N-PV	36 x 30 x 29		\$944	
	LT4230N-PV	42 x 30 x 29	Table has PVC edge with a flat flip top	\$1019	
LT4830N-PV	48 x 30 x 29	cord manager box on back side of table	\$1114		
LT5430N-PV	54 x 30 x 29	end of cord box. Ships knocked down	\$1209		
LT6030N-PV	60 x 30 x 29	with one leg.	\$1308		
LT6630N-PV	66 x 30 x 29		\$1402		
LT7230N-PV	72 x 30 x 29		\$1501		

# Tables

## VISTA Training Tables

	Catalog Number	Dimensions			Description	List Price
		W	x	D		
<b>Standard product features include:</b>	TT2424HCC-PV	24	x	24	VISTA Training Tables	644
• VISTA Training Tables part numbering begin with a “TT” for Training Table followed by dimensions [ 60W x 30D ], then references to back panel [ 3/4 ], legs [ C-Legs], and edge treatment. Ex: TT6030HCC-PV	TT3024HCC-PV	30	x	24		647
• High pressure laminate tops have balanced construction w/3mm PVC.	TT3624HCC-PV	36	x	24		681
• Legs are 2” thick, all steel construction with smooth, rounded edges and leveling glides; Quick Ship Program include C-Legs. Other leg options with standard product line are: Access Leg, Full End Panel, Shared C-Leg and Shared Access Leg. All legs are non-handed and include grommets for vertical and horizontal wire management.	TT4224HCC-PV	42	x	24		769
• Environmentally friendly powder coat painted metal components.	TT4824HCC-PV	48	x	24		823
• May be ganged and outfitted with 8 wire / 4 circuits, &/or pop-up utilities [Additional charges apply.]	TT5424HCC-PV	54	x	24		873
• Modesty back panels are all steel construction and are available in various heights. Included in Quick Ship is 3/4 Height. Standard line options include: Full Height and Wall Access Height. VISTA tables come standard with cable channel.	TT6024HCC-PV	60	x	24		938
• All tables are cartoned and ship K.D. (knocked down).	TT6624HCC-PV	66	x	24		999
• Two grommets per table in tables 54” wide and larger. One grommet per table in tables 48” wide and smaller. Grommets are round.	TT7224HCC-PV	72	x	24		1053
	TT2430HCC-PV	24	x	30		717
	TT3030HCC-PV	30	x	30		722
	TT3630HCC-PV	36	x	30		744
	TT4230HCC-PV	42	x	30		803
	TT4830HCC-PV	48	x	30		857
	TT5430HCC-PV	54	x	30		938
	TT6030HCC-PV	60	x	30		999
	TT6630HCC-PV	66	x	30		1053
	TT7230HCC-PV	72	x	30		1098
	TT2436HCC-PV	24	x	36	<b>NOTE: 36” tables have a 6” overhang on public side.</b>	681
	TT3036HCC-PV	30	x	36		744
	TT3636HCC-PV	36	x	36		774
	TT4236HCC-PV	42	x	36		857
	TT4836HCC-PV	48	x	36		938
	TT5436HCC-PV	54	x	36		999
	TT6036HCC-PV	60	x	36		1062
	TT6636HCC-PV	66	x	36		1105
	TT7236HCC-PV	72	x	36		1175

Standard height is 29”H.  
 Also available in 26”H, 32”H and 42”H by special request.  
 Insert the appropriate acronym in the item part number.  
 i.e. K for 26”H, an A for 32”H, and a S for 42” H.  
 Example: TTA2424HCC-PV  
 Call our Bid Analyst for special pricing at 877.682.4601



# Tables

## Elevation Series

	Catalog Number	Dimensions			Description	List Price
		W	x	D		
	ETM6030B-C-TE	60	x	30	with locking pedestal	\$2551
	ETM7230B-C-TE	72	x	30	with locking pedestal	\$2643
	ETM6024-C-TE	60	x	24	without pedestal	\$2072
	ETM7224-C-TE	72	x	24	without pedestal	\$2135

**Worksurface of table may elevate from 28-1/2"H to 41-3/4"H**

## Drafting Table

	Catalog Number	Dimensions			List Price
		W	x	D x H	
	DT3630HEE-36T-PV	36	x	30x29	\$1380
	DT4230HEE-42T-PV	42	x	30x29	\$1437
	DT4830HEE-48T-PV	48	x	30x29	\$1495
	DT6030HEE-36T^A-PV	60	x	30x29	\$2251
	DTM3630HEE-36T-PV	36	x	30x29	\$1473
	DTM4230HEE-42T-PV	42	x	30x29	\$1530
	DTM4830HEE-48T-PV	48	x	30x29	\$1588
	DTM6030HEE-36T^A-PV	60	x	30x29	\$2344

60x30 with a 36" Tilt Top, please specify left (L) or right (R) at location of carat (^).

**Tilt-top drafting surface that may be adjusted from flat to 45 degrees**

## Peninsula Mobile Breakaway Table

Catalog Number	Dimensions			List Description	Ship Price	Weight
	W	D	H			
RTPBTM48-TE	48	x	39	For mobile desks, on casters	\$808	80
RTPBTM48-29-TE	48	x	39	For standard height desks	\$808	77



*Match form fit to any 30" deep desk with 1-5/8 radius corners.*

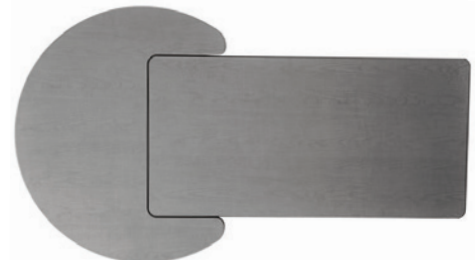

# Tables

## Freedom Tables

Choose the edge treatment. Replace \*\* within part number with -TE for T-Mold, -PV for PVC, and -SE for Self-Edge.

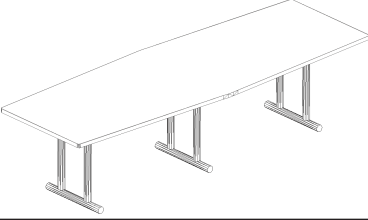
Boat	Catalog Number	Dimensions	Description	List Price	Ship Weight
	FTB6036NTT**	60x36		\$1134	
	FTB7236NTT**	72x36		\$1254	
	FTB8436NTT**	84X36		\$1472	
	FTB9642NTT**	96x42	double T leg	\$1979	
	FTB9648NTT**	96x48		\$2457	
	FTB12042NTT**	120x42	triple T leg	\$2281	

## Raceway

	FTR7236NTT**	72x36		\$1254	
	FTR8436NTT**	84x36		\$1472	
	FTR9636NTT**	96X36		\$1546	
	FTR9642NTT**	96X42	double T leg	\$1979	
	FTR9648NTT**	96x48		\$2137	
	FTR10842NTT**	108x42		\$2390	
	FTR12042NTT**	120x42	triple T leg	\$2457	
	FTR12048NTT**	120x48		\$2869	

## Square

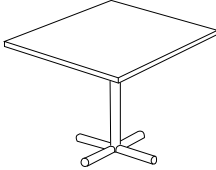
	FT3030-**	30 x 30		\$782	48
	FT3636-**	36 x 36		\$892	74
	FT4242-**	42 x 42		\$1135	92

## Round

	FT36-**	36 Diameter		\$923	48
	FT42-**	42 Diameter		\$1209	88
	FT48-**	48 Diameter		\$1329	112
	FT60-**	60 Diameter		\$1753	132

NOTE: Tables also available in other heights. Consult factory.  
Example: FT36\*\*-42H This is a 36 diameter table with a height of 41". Price: \$1168

## Rectangular

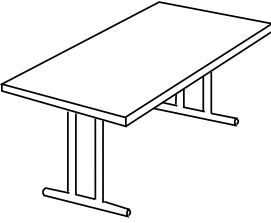
	FT6024NTT-**	60x24		\$1064	84
	FT7224NTT-**	72x24	single T leg	\$1092	90
	FT6030NTT-**	60x30		\$1119	92
	FT7230NTT-**	72x30		\$1173	109
	FT7236NTT-**	72x36		\$1372	126
	FT8436NTT-**	84x36		\$1477	153
	FT8442NTT-**	84x42	double T leg	\$1606	178
	FT9642NTT-**	96x42		\$1646	192

Oval and rectangular tables over 30" wide have double column legs.

# Tables

## Freedom Tables

### Folding Leg Tables

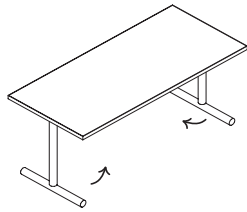

	Catalog Number	Dimensions W x D x H	Description	List Price
(30" deep)	FT6030F-PV	60 x 30 x 29	Top has PVC edging. Legs fold flat.	\$1190
	FT6630F-PV	66 x 30 x 29		\$1253
	FT7230F-PV	72 x 30 x 29	Folded height is 5".	\$1345
(24" deep)	FT6024F-PV	60 x 24 x 29	Top has PVC edge. Legs fold flat.	\$1124
	FT6624F-PV	66 x 24 x 29		\$1173
	FT7224F-PV	72 x 24 x 29	Folded height is 5"	\$1265

### Fixed Leg Tables

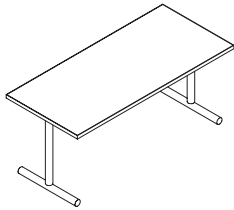

	Catalog Number	Dimensions W x D x H	Description	List Price
(30" deep)	FT4230-PV	42 x 30 x 29	Top has PVC edge. Legs Do Not Fold.	\$1021
	FT4830-PV	48 x 30 x 29		\$1038
	FT5430-PV	54 x 30 x 29		\$1053
	FT6030-PV	60 x 30 x 29		\$1101
	FT6630-PV	66 x 30 x 29		\$1147
	FT7230-PV	72 x 30 x 29		\$1194
(24" deep)	FT4224-PV	42 x 24 x 29	Top has PVC edging. Legs do not fold.	\$958
	FT4824-PV	48 x 24 x 29		\$973
	FT5424-PV	54 x 24 x 29		\$989
	FT6024-PV	60 x 24 x 29		\$1033
	FT6624-PV	66 x 24 x 29		\$1060
	FT7224-PV	72 x 24 x 29		\$1126

## R-Series with 2-1/4" Round Painted Legs

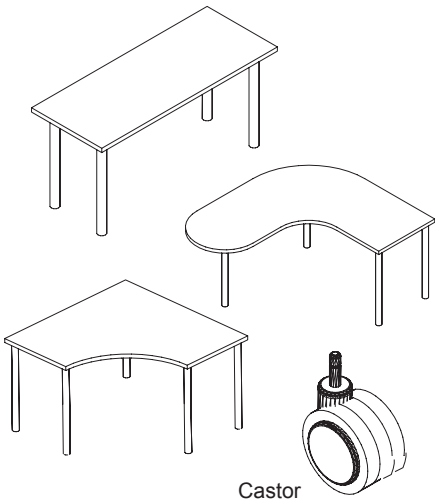

Castor

Catalog Number	W	D	H	Description	List Price	Ship Weight
RT7236-PV	72	36	29	Rectangular Table without drawer	\$873	126
RT6030-PV	60	30	29	Rectangular Table without drawer	\$809	92
RT6024-PV	60	24	29	Rectangular Table without drawer	\$745	74
RTPL6048-PV	60	48	29	Peninsula Table - left	\$950	130
RTPL4848-PV	48	48	29	Peninsula Table - left	\$917	120
RTPR6048-PV	60	48	29	Peninsula Table - right	\$950	130
RTPR4848-PV	48	48	29	Peninsula Table - right	\$917	120
RTC3636-PV	36	36	29	Corner Table	\$888	94
RTC4242-PV	36	36	29	Corner Table	\$917	100
RTC10-PV				Table Joining Clamp	\$50	

For a mobile table, add an "M" to the prefix for 4" locking castors (Package of 4). \$226

Example: RTC3636 becomes a RTCM3636 for a mobile table.

## S-Series with 1" Square Painted Legs

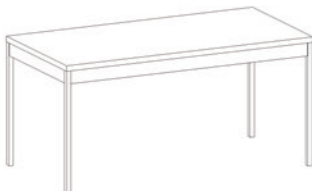

Catalog Number	Dimensions	List Description	Ship Price	Weight
S-T7236P-SE	72 x 36 x 29	Table without drawer	\$1197	126
S-T6030P-SE	60 x 30 x 29	Table without drawer	\$903	92
S-T6020P-SE	60 x 19-5/8 x 29	Table without drawer	\$745	74

NOTE: Table top is flush on all sides. Bolt on 1" square painted legs are standard.

# Panel Systems Furniture



## GENERAL PRODUCT INFORMATION

### System Panels

- Available in nine (9) widths and five (5) heights as standard
- Wood trim panels are available. (Consult the factory for ordering information and pricing)
- Special height panels are available. (Consult the factory for ordering information and pricing)
- Panels are fabric covered, tackable and acoustical with divided base raceways and electrical power capabilities. Includes vertical and horizontal hang-on provisions. Panels are also offered split fabric/glazed, full glazed—straight, and a 79" high laminated door panel with lock set.
- Panels are constructed using monocoque design giving structural rigidity with weight control. Honeycomb core material is bonded to steel skin. Innocuous foam covers steel skin with class 1 or grade A fabric covering all surfaces. Powder coat painted top rails and bottom raceway covers facilitates cleaning. Metal connectors used at all panel joints (not plastic). Panels are connected end to end in a straight run. Posts are used at corners to angle off in another direction and fills opening created by angled panels. Bottom corner fillers provided to conceal electrical panel to panel connections.
- Mid-panel connections are accomplished with same height panels only and must be 90°. Note: Electrical connections may not run through mid panel joint. Multiple height panels may be connected at ends of any panel or at corners.

### Systems Worksurfaces

- Worksurfaces are high pressure laminate with vinyl T-edge molding all around. Worksurfaces have 1-1/8" corner radius. Standard depth worksurfaces have one cord relief centered on back edge. Additional cord reliefs or grommets are available.
- Desk top electrical and communication outlets are available.
- Transaction surfaces are without cord reliefs and two pairs of attaching brackets are provided. Standard worksurfaces include one pair of cantilevered support brackets that lock in place (additional support may be required). Individual brackets may be ordered at upcharge.

### Systems Panel Mounted Components

- Components including worksurface cantilever brackets lock into panel uprights at 1-1/2" increments. Shelving components including ends and attaching brackets are powder coat painted steel. Doors of standard overhead RDU are steel. Laminate or fabric covered RDU doors are available at extended lead times. Consult factory.
- Unique panel top rail mounting brackets allow components; i.e. bookshelves and receding door units, to be positioned diagonally above corner worksurfaces.
- Horizontal wall mounting track available. Attaches directly to building wall. (Fastening method to be determined by installer.) **Invincible™ will not assume responsibility for method of attachment.**

### Pedestals

- Pedestals available in a variety of styles including mobile, freestanding, and suspended (under surface mounted). Most pedestals are offered in letter width. All pedestals available with locks. All drawers have full width recessed pulls or laminate with waterfall pull.
- Box drawers have multi-formed construction with interior having one cross divider. File drawers have front to back hanging folder rails as standard. A compressor may be substituted with an upcharge if specified at time of order.
- Locking option: Pedestals may be keyed alike to other units.

*\* To order Pedestals, Center Drawers, Keyboard Trays and other Accessories see pages 18 to 22.*



# Systems Furniture

## Standard Dimensions

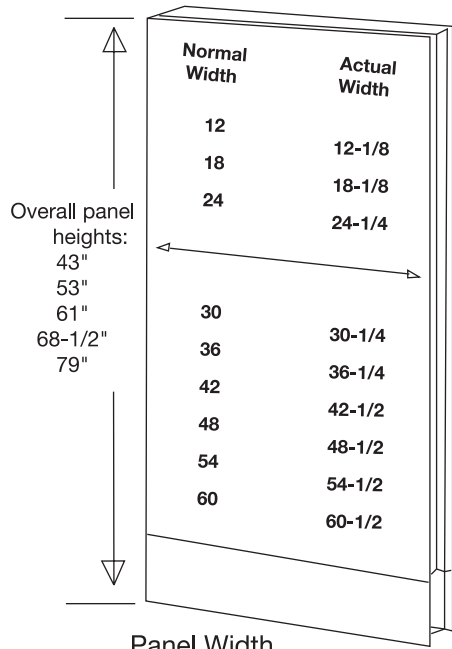

(use examples above to figure length of panel run)

### Standard Corner Worksurface Diagonal Dimensions

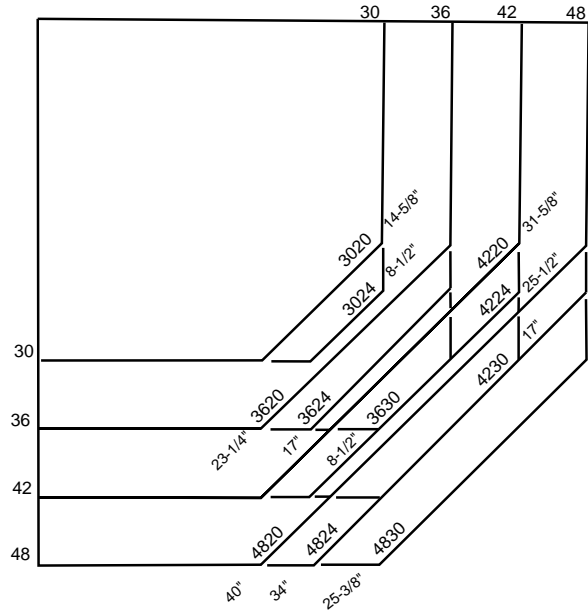

## STANDARD INSTALLATION WORKSURFACE CLEARANCE

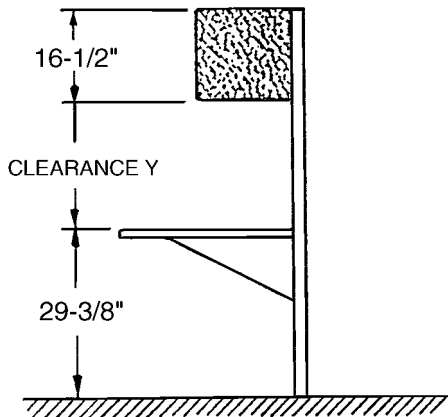

Panel Height	Clearance "Y"
79"	33-1/8"
68"	22-5/8"
61"	15-1/8"
53"	Not Recommended
43"	Not Recommended

# Systems Furniture

## Power Distribution System

The power system is a 20 amp 8 wire plug-in type power distribution system with 4 individual circuits providing a practical alternative to high cost, labor-intensive methods of providing electrical outlets and task lighting circuits in open plan furniture.

The pre-wired panels offer flexibility which may be easily and reliably interconnected on site, or retrofitted with duplex receptacles in the field after installation.

The system allows for tapping off of energy saving task lighting as well as providing the capability for 2 optional dedicated circuits for information technology terminals as required:

- Four available circuits accommodate up to 13 duplex receptacles per circuit.
- All electrical components are Underwriter Laboratory approved.
- Base or ceiling entry infeeds available for power source situation.
- 15 amp duplex receptacles have back to back capability and are interchangeable.
- If requested, panels are pre-wired at factory except where local electrical code prohibits.

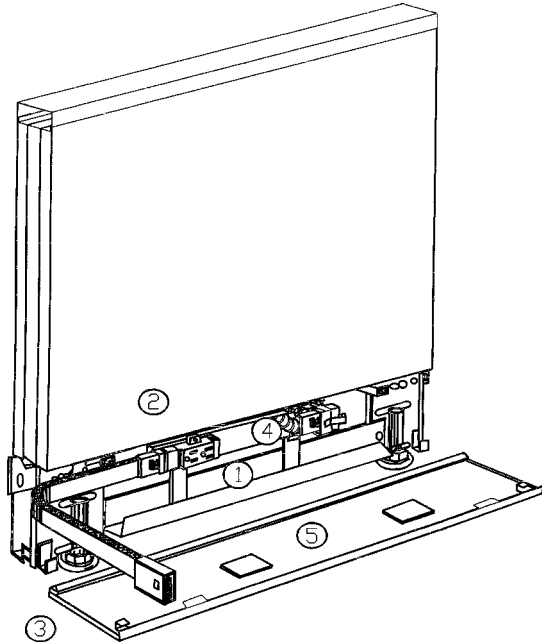

**1. DIVIDED POWER RACEWAY** – Used to divide communications and computer cables from higher voltage electrical cables. Base raceway capable of handling up to 8-25 pair cables.

**2. DUPLEX RECEPTACLES** – Provides two electrical outlets per receptacle, may be ordered in 4 different circuits.

- Circuit 1 - Utility Circuit  
Used with 3 phase or single phase
- Circuit 2 - Utility Circuit  
Used only with 3 phase WYE power
- Circuit 3 - Utility Circuit  
Used with 3 phase or single phase
- Circuit 4 - Computer circuit  
Used with 3 phase or single phase

**3. INTERCONNECTING CABLE** – Used to pass power from panel to panel.

**4. CHANNEL ASSEMBLY** – Supplied with electrified panel, used as a pass thru or as a power assembly when receptacles added. 12", 18" and 24" panels have pass-thru power only. 30" panels have 1 receptacle per side. All other panels sizes are capable of 2 per side.

**5. RACEWAY COVERS** – Metal face plates lock in place to cover raceway. Supplied with panel (completely removable).

When ordering power for system:

- Order style of power entry needed
- Order appropriate powered panel
- Order quantity and color of duplex receptacles required for each circuit.

## Electrical Installations

All electrical installations must be made by a qualified electrician in accordance with local codes. Invincible may not be held responsible for installations not meeting local codes. Electrical installation guide included with SCA18 or base feed.

# 32" High Panels

## Non Powered Panels

## Powered Panels

Panel Description	Catalog Number	List Price	Catalog Number	List Price	Ship Weight
<b>Straight Fabric Panels</b>					
12" W	1232	\$786	1232A	\$961	38
18" W	1832	\$789	1832A	\$966	45
24" W	2432	\$805	2432A	\$989	52
30" W	3032	\$818	3032A	\$1009	59
36" W	3632	\$911	3632A	\$1107	66
42" W	4232	\$1002	4232A	\$1220	73
48" W	4832	\$1071	4832A	\$1276	80
54" W	5432	\$1122	5432A	\$1326	87
60" W	6032	\$1149	6032A	\$1362	94

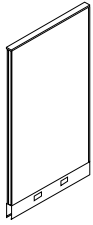

Catalog Number	Description	List Price	Ship Weight
<b>Round Connecting Posts</b>			
RPP32	Round painted post. Includes top caps and raceway cover.	\$93	6
RPF32	Round fabric post	\$124	6

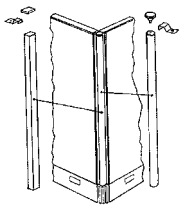

Catalog Number	Description	List Price	Ship Weight
<b>Square Connecting Posts</b>			
SPP32	Square painted post. Includes top caps and raceway cover.	\$181	6
SPF32	Square fabric post	\$218	6

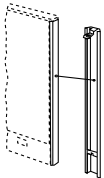

Catalog Number	Description	List Price	Ship Weight
<b>Panel Trim Ends</b>			
TP32	Painted trim end	\$57	7
TF32	Fabric trim end	\$86	7

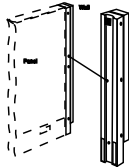

Catalog Number	Description	List Price	Ship Weight
<b>90° Wall Starter Bracket</b>			
WSB32	Painted wall starter bracket. Starts panel run perpendicular (90°) from wall	\$136	8

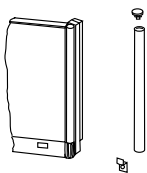

Catalog Number	Description	List Price	Ship Weight
<b>Multi-Angle Wall Starter Bracket</b>			
WSA32	Wall starter bracket and round painted post. Starts panel run at any angle from wall.	\$227	14
WSAF32	Wall starter bracket and round fabric post. Starts panel run at any angle from wall.	\$248	14

**Must order receptacles and  
ICA cables separately.  
See page 74.**

### SPECIFIC PRODUCT INFORMATION

Straight powered panels have divided base raceway with covers, top cap and include connecting clips. Receptacles are ordered separately and install into knockout plates. Order trim ends/posts for panels separately. Wood trim panels are available.

# 43" High Panels

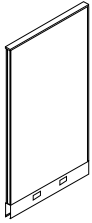

## Non Powered Panels

Panel Description	Catalog Number	List Price
<b>Straight Fabric Panels</b>		
12" W	1243	\$818
18" W	1843	\$822
24" W	2443	\$838
30" W	3043	\$849
36" W	3643	\$949
42" W	4243	\$1043
48" W	4843	\$1124
54" W	5443	\$1178
60" W	6043	\$1206

## Powered Panels

Catalog Number	Description	List Price	Ship Weight
<b>Straight Fabric Panels</b>			
1243A		\$1007	38
1843A		\$1014	45
2443A		\$1040	52
3043A		\$1049	59
3643A		\$1165	66
4243A		\$1273	73
4843A		\$1326	80
5443A		\$1396	87
6043A		\$1436	94

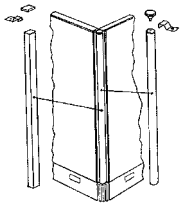

Catalog Number	Description	List Price	Ship Weight
<b>Round Connecting Posts</b>			
RPP43	Round painted post. Includes top caps and raceway cover.	\$97	6
RPF43	Round fabric post	\$134	6

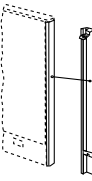

Catalog Number	Description	List Price	Ship Weight
<b>Square Connecting Posts</b>			
SPP43	Square painted post. Includes top caps and raceway cover.	\$188	6
SPF43	Square fabric post	\$225	6

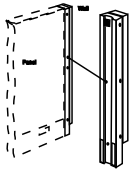

Catalog Number	Description	List Price	Ship Weight
<b>Panel Trim Ends</b>			
TP43	Painted trim end	\$59	7
TF43	Fabric trim end	\$90	7

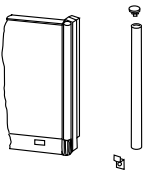

Catalog Number	Description	List Price	Ship Weight
<b>90° Wall Starter Bracket</b>			
WSB43	Painted wall starter bracket. Starts panel run perpendicular (90°) from wall	\$156	9
<b>Multi-Angle Wall Starter Bracket</b>			
WSA43	Wall starter bracket and round painted post. Starts panel run at any angle from wall.	\$241	15
WSAF43	Wall starter bracket and round fabric post. Starts panel run at any angle from wall.	\$262	15

**Must order receptacles and ICA cables separately. See page 74.**

### SPECIFIC PRODUCT INFORMATION

Straight powered panels have divided base raceway with covers, top cap and include connecting clips. Receptacles are ordered separately and install into knockout plates. Order trim ends/posts for panels separately. Wood trim panels are available.

# 53" High Panels

## Non Powered Panels

## Powered Panels

Panel Description	Catalog Number	List Price	Catalog Number	List Price	Ship Weight
<b>Straight Fabric Panels</b>					
12" W	1253	\$831	1253A	\$1009	42
18" W	1853	\$858	1853A	\$1043	50
24" W	2453	\$896	2453A	\$1107	62
30" W	3053	\$958	3053A	\$1170	67
36" W	3653	\$1024	3653A	\$1242	76
42" W	4253	\$1089	4253A	\$1314	84
48" W	4853	\$1182	4853A	\$1403	93
54" W	5453	\$1240	5453A	\$1478	97
60" W	6053	\$1258	6053A	\$1489	101



Catalog Number	Description	List Price	Ship Weight
----------------	-------------	------------	-------------

## Round Connecting Posts

RPP53	Round painted post. Includes top caps and raceway cover.	\$124	7
RPF53	Round fabric post. Includes top caps and raceway cover.	\$160	7

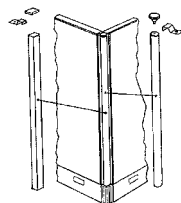

## Square Connecting Posts

SPP53	Square painted post. Includes top caps and raceway cover.	\$188	7
SPF53	Square fabric post. Includes top caps and raceway cover.	\$227	7

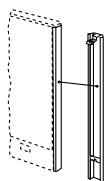

## Panel Trim Ends

TP53	Painted trim end	\$62	8
TF53	Fabric trim end	\$99	8

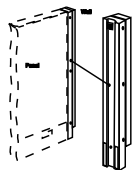

## 90° Wall Starter Bracket

WSB53	Painted wall starter bracket. Starts panel run perpendicular (90°) from wall	\$156	11
-------	---	-------	----

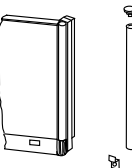

## Multi-Angle Wall Starter Bracket

WSA53	Wall starter bracket and round painted post. Starts panel run at any angle from wall.	\$243	17
WSAF53	Wall starter bracket and round fabric post. Starts panel run at any angle from wall.	\$271	17

### SPECIFIC PRODUCT INFORMATION

Straight powered panels have divided base raceway with covers, top cap and include connecting clips. Receptacles are ordered separately and install into knockout plates. Order trim ends/posts for panels separately. Wood trim panels are available.

**Must order receptacles and  
ICA cables separately.  
See page 74.**

# 61" High Panels

## Non Powered Panels

## Powered Panels

Panel Description	Catalog Number	List Price	Catalog Number	List Price	Ship Weight
<b>Straight Fabric Panels</b>					
12" W	1261	\$880	1261A	\$1074	45
18" W	1861	\$920	1861A	\$1120	55
24" W	2461	\$949	2461A	\$1156	65
30" W	3061	\$980	3061A	\$1196	75
36" W	3661	\$1071	3661A	\$1283	85
42" W	4261	\$1149	4261A	\$1378	95
48" W	4861	\$1198	4861A	\$1429	105
54" W	5461	\$1251	5461A	\$1501	115
60" W	6061	\$1273	6061A	\$1542	125
<b>Clear Glazed Panels</b>					
24" W	G2461	\$1156	G2461A	\$1345	65
30" W	G3061	\$1185	G3061A	\$1378	75
36" W	G3661	\$1211	G3661A	\$1410	85
42" W	G4261	\$1360	G4261A	\$1605	95
<b>Tinted Glazed Panels</b>					
24" W	TG2461	\$1144	TG2461A	\$1396	65
30" W	TG3061	\$1167	TG3061A	\$1415	75
36" W	TG3661	\$1247	TG3661A	\$1482	85
42" W	TG4261	\$1389	TG4261A	\$1621	95
<b>Split Clear Glazed &amp; Fabric Panels</b>					
24"	H2461-1G	\$1343	H2461A-1G	\$1569	65
30"	H3061-1G	\$1398	H3061A-1G	\$1621	75
36"	H3661-1G	\$1478	H3661A-1G	\$1667	85
42"	H4261-1G	\$1542	H4261A-1G	\$1787	95
<b>Split Tinted Glazed &amp; Fabric Panels</b>					
24" W	TH2461-1G	\$1389	TH2461A-1G	\$1523	65
30" W	TH3061-1G	\$1415	TH3061A-1G	\$1650	75
36" W	TH3661-1G	\$1520	TH3661A-1G	\$1756	85
42" W	TH4261-1G	\$1624	TH4261A-1G	\$1867	95

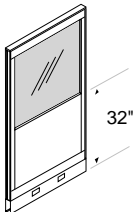
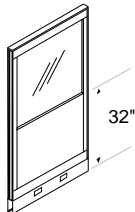
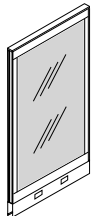
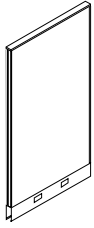

**Must order receptacles and ICA cables separately. See page 74.**

**SPECIFIC PRODUCT INFORMATION**

Straight powered panels have divided base raceway with covers, top cap and include connecting clips. Receptacles are ordered separately and install into knockout plates. Order trim ends/posts for panels separately. Wood trim panels are available.

# 61" High Panels

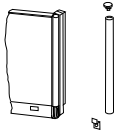
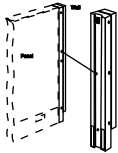
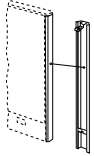
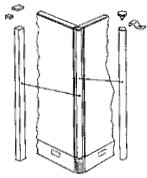

Catalog Number	Description	List Price	Ship Weight
<b>Round Connecting Posts</b>			
RPP61	Round painted post. Includes top caps and raceway cover.	\$143	8
RPF61	Round fabric post. Includes top caps and raceway cover.	\$181	8
<b>Square Connecting Posts</b>			
SPP61	Square painted post. Includes top caps and raceway cover.	\$198	8
SPF61	Square fabric post. Includes top caps and raceway cover.	\$236	8
<b>Panel Trim Ends</b>			
TP61	Painted trim end	\$67	7
TF61	Fabric trim end	\$99	7
<b>90° Wall Starter Bracket</b>			
WSB61	Painted wall starter bracket. Starts panel run perpendicular (90°) from wall	\$167	12
<b>Multi-Angle Wall Starter Bracket</b>			
WSA61	Wall starter bracket and round painted post. Starts panel run at any angle from wall.	\$248	19
WSAF61	Wall starter bracket and round fabric post. Starts panel run at any angle from wall.	\$273	19

**Must order receptacles and  
ICA cables separately.  
See page 74.**

**SPECIFIC PRODUCT INFORMATION**

Straight powered panels have divided base raceway with covers, top cap and include connecting clips. Receptacles are ordered separately and install into knockout plates. Order trim ends/posts for panels separately. Wood trim panels are available.

# 68" High Panels

## Non Powered Panels

## Powered Panels

Panel Description	Catalog Number	List Price	Catalog Number	List Price	Ship Weight
<b>Straight Fabric Panels</b>					
12" W	1268	\$918	1268A	\$1131	50
18" W	1868	\$958	1868A	\$1185	60
24" W	2468	\$989	2468A	\$1218	70
30" W	3068	\$1049	3068A	\$1271	81
36" W	3668	\$1122	3668A	\$1353	91
42" W	4268	\$1218	4268A	\$1446	103
48" W	4868	\$1278	4868A	\$1520	114
54" W	5468	\$1336	5468A	\$1573	125
60" W	6068	\$1343	6068A	\$1583	136



## Clear Glazed Panels

12" W	G1268	\$1093	G1268A	\$1285	50
18" W	G1868	\$1115	G1868A	\$1307	60
24" W	G2468	\$1163	G2468A	\$1386	70
30" W	G3068	\$1196	G3068A	\$1415	81
36" W	G3668	\$1247	G3668A	\$1487	91
42" W	G4268	\$1369	G4268A	\$1616	103

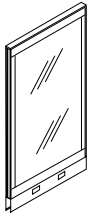

## Tinted Glazed Panels

12" W	TG1268	\$1196	TG1268A	\$1413	50
18" W	TG1868	\$1206	TG1868A	\$1427	60
24" W	TG2468	\$1216	TG2468A	\$1436	70
30" W	TG3068	\$1230	TG3068A	\$1465	81
36" W	TG3668	\$1331	TG3668A	\$1561	91
42" W	TG4268	\$1473	TG4268A	\$1715	103

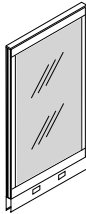

## Split Clear Glazed & Fabric Panels

24" W	H2468-1G	\$1353	H2468A-1G	\$1590	70
30" W	H3068-1G	\$1420	H3068A-1G	\$1662	80
36" W	H3668-1G	\$1482	H3668A-1G	\$1729	90
42" W	H4268-1G	\$1600	H4268A-1G	\$1852	100

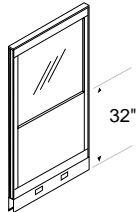

## Split Tinted Glazed & Fabric Panels

24" W	TH2468-1G	\$1470	TH2468A-1G	\$1696	70
30" W	TH3068-1G	\$1523	TH3068A-1G	\$1763	80
36" W	TH3668-1G	\$1624	TH3668A-1G	\$1871	90
42" W	TH4268-1G	\$1736	TH4268A-1G	\$1974	100

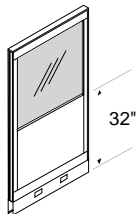

**Must order receptacles and ICA cables separately.  
See page 74.**

### SPECIFIC PRODUCT INFORMATION

Straight powered panels have divided base raceway with covers, top cap and include connecting clips. Receptacles are ordered separately and install into knockout plates. Order trim ends/posts for panels separately. Wood trim panels are available.



# 68" High Panels

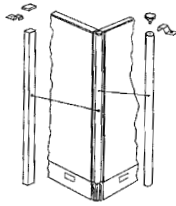

Catalog Number	Description	List Price	Ship Weight
<b>Round Connecting Posts</b>			
RPP68	Round painted post. Includes top caps and raceway cover.	\$150	9
RPF68	Round fabric post	\$184	9

<b>Square Connecting Posts</b>			
SPP68	Square painted post. Includes top caps and raceway cover.	\$204	9
SPF68	Square fabric post	\$287	9

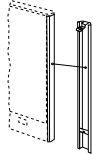

<b>Panel Trim Ends</b>			
TP68	Painted trim end	\$67	8
TF68	Fabric trim end	\$103	8

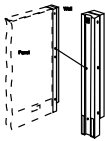

<b>90° Wall Starter Bracket</b>			
WSB68	Painted wall starter bracket. Starts panel run perpendicular (90°) from wall	\$167	12
WSB68-6	Painted wall starter bracket extender. Starts panel run perpendicular (90°) from wall	\$315	26

<b>Multi-Angle Wall Starter Bracket</b>			
WSA68	Wall starter bracket and round painted post. Starts panel run at any angle from wall.	\$250	21
WSAF68	Wall starter bracket and round fabric post. Starts panel run at any angle from wall.	\$273	21

**Must order receptacles and  
ICA cables separately.  
See page 74.**

**SPECIFIC PRODUCT INFORMATION**

Straight powered panels have divided base raceway with covers, top cap and include connecting clips. Receptacles are ordered separately and install into knockout plates. Order trim ends/posts for panels separately. Wood trim panels are available.

# 79" High Panels

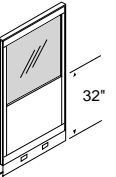
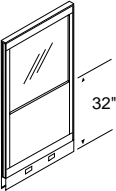
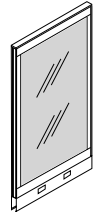
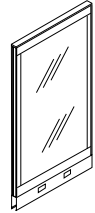
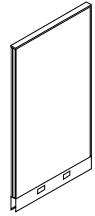

## Non Powered Panels

## Powered Panels

Panel Width	Catalog Number	List Price	Catalog Number	List Price	Ship Weight
<b>Straight Fabric Panels</b>					
12" W	1279	\$1089	1279A	\$1307	65
18" W	1879	\$1136	1879A	\$1360	75
24" W	2479	\$1144	2479A	\$1362	85
30" W	3079	\$1182	3079A	\$1398	96
36" W	3679	\$1266	3679A	\$1482	107
42" W	4279	\$1343	4279A	\$1558	118
48" W	4879	\$1374	4879A	\$1600	129
<b>Clear Glazed Panels</b>					
12" W	G1279	\$1278	G1279A	\$1451	65
18" W	G1879	\$1302	G1879A	\$1480	75
24" W	G2479	\$1333	G2479A	\$1516	85
30" W	G3079	\$1360	G3079A	\$1571	96
36" W	G3679	\$1420	G3679A	\$1631	107
42" W	G4279	\$1506	G4279A	\$1731	118
<b>Tinted Glazed Panels</b>					
12" W	TG1279	\$1333	TG1279A	\$1542	65
18" W	TG1879	\$1347	TG1879A	\$1566	75
24" W	TG2479	\$1393	TG2479A	\$1616	85
30" W	TG3079	\$1441	TG3079A	\$1633	96
36" W	TG3679	\$1460	TG3679A	\$1660	107
42" W	TG4279	\$1520	TG4279A	\$1738	118
<b>Split Clear Glazed &amp; Fabric Panels</b>					
24" W	H2479-1G	\$1501	H2479A-1G	\$1715	85
30" W	H3079-1G	\$1530	H3079A-1G	\$1753	96
36" W	H3679-1G	\$1636	H3679A-1G	\$1849	107
42" W	H4279-1G	\$1749	H4279A-1G	\$1974	118
<b>Split Tinted Glazed &amp; Fabric Panels</b>					
24" W	TH2479-1G	\$1506	TH2479A-1G	\$1710	85
30" W	TH3079-1G	\$1605	TH3079A-1G	\$1804	96
36" W	TH3679-1G	\$1727	TH3679A-1G	\$1943	107
42" W	TH4279-1G	\$1830	TH4279A-1G	\$2044	118

**Must order receptacles and ICA cables separately. See page 74.**

**SPECIFIC PRODUCT INFORMATION**

Straight powered panels have divided base raceway with covers, top cap and include connecting clips. Receptacles are ordered separately and install into knockout plates. Order trim ends/posts for panels separately. Wood trim panels are available.

# 79" High Panels

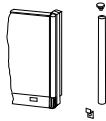
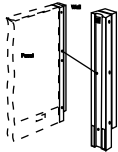
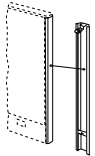
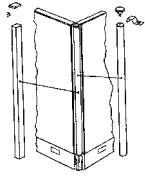

Catalog Number	Description	List Price	Ship Weight
<b>Round Connecting Posts</b>			
RPP79	Round painted post. Includes top caps and raceway cover.	\$158	10
RPF79	Round fabric post	\$190	10
<b>Square Connecting Posts</b>			
SPP79	Square painted post. Includes top caps and raceway cover.	\$211	10
SPF79	Square fabric post	\$322	10
<b>Panel Trim Ends</b>			
TP79	Painted trim end	\$74	8
TF79	Fabric trim end	\$103	8
<b>90° Wall Starter Bracket</b>			
WSB79	Painted wall starter bracket. Starts panel run perpendicular (90°) from wall	\$170	13
WSB79-6	Painted wall starter bracket. Starts panel run perpendicular (90°) from wall Closes the 3.5" and opens up to 6"	\$308	26
<b>Multi-Angle Wall Starter Bracket</b>			
WSA79	Wall starter bracket and round painted post. Starts panel run at any angle from wall.	\$257	23
WSAF79	Wall starter bracket and round fabric post. Starts panel run at any angle from wall.	\$285	23
<b>Door Panel – laminate door with painted frame and trim</b>			
DOOR36R	Door fits into 36" panel opening.	\$2474	40
DOOR42R	Door fits into 42" panel opening. For handicapped entry	\$2585	48
DOOR36L	Door fits into 36" panel opening.	\$2474	40
DOOR42L	Door fits into 42" panel opening. For handicapped entry.	\$2585	40

NOTE: 36" door has 29-5/8" clear opening. 42" door has 35-7/8" clear opening.

**SPECIFIC PRODUCT INFORMATION**

Straight powered panels have divided base raceway with covers, top cap and include connecting clips. Receptacles are ordered separately and install into knockout plates. Order trim ends/posts for panels separately. Laminate door will fit into either a 36" or 42" panel opening. Actual door is 31-3/4" wide for 36" panels, 37-3/4" for 42" panels. Wood trim panels available.

# Multi-Height Panel Connectors

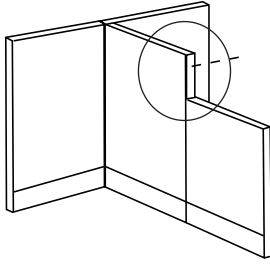

Catalog Number	Length	Panels being joined	Trim Finish	List Price	Ship Weight
<b>Flat Trim – No post</b>					
FT3243	11	32"H panel connecting 43"H panel	Painted	\$82	3
FT3253	21	32"H panel connecting 53"H panel	Painted	\$87	3
FT3261	29	32"H panel connecting 61"H panel	Painted	\$93	3
FT3268	36	32"H panel connecting 68"H panel	Painted	\$97	3
FT3279	47	32"H panel connecting 79"H panel	Painted	\$108	4
FT4353	10	43"H panel connecting 53"H panel	Painted	\$81	3
FT4361	18	43"H panel connecting 61"H panel	Painted	\$86	3
FT4368	25	43"H panel connecting 68"H panel	Painted	\$88	3
FT4379	36	43"H panel connecting 79"H panel	Painted	\$97	3
FT5361	8	53"H panel connecting 61"H panel	Painted	\$80	2
FT5368	15	53"H panel connecting 68"H panel	Painted	\$83	3
FT5379	26	53"H panel connecting 79"H panel	Painted	\$89	3
FT6168	7	61"H panel connecting 68"H panel	Painted	\$80	2
FT6179	18	61"H panel connecting 79"H panel	Painted	\$86	3
FT6879	11	68"H panel connecting 79"H panel	Painted	\$82	3

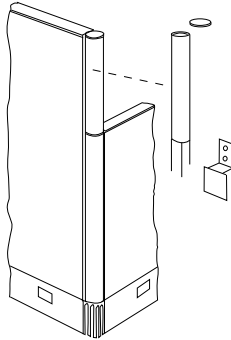

Catalog Number	Length	Panels being joined	Trim Finish	List Price	Ship Weight
<b>Round Post Painted Extensions</b>					
RPPE3243	11	32"H panel connecting 43"H panel	Painted	\$119	6
RPPE3253	21	32"H panel connecting 53"H panel	Painted	\$125	6
RPPE3261	29	32"H panel connecting 61"H panel	Painted	\$129	7
RPPE3268	36	32"H panel connecting 68"H panel	Painted	\$130	7
RPPE3279	47	32"H panel connecting 79"H panel	Painted	\$132	8
RPPE4353	10	43"H panel connecting 53"H panel	Painted	\$118	6
RPPE4361	18	43"H panel connecting 61"H panel	Painted	\$124	6
RPPE4368	25	43"H panel connecting 68"H panel	Painted	\$126	7
RPPE4379	36	43"H panel connecting 79"H panel	Painted	\$130	7
RPPE5361	8	53"H panel connecting 61"H panel	Painted	\$117	5
RPPE5368	15	53"H panel connecting 68"H panel	Painted	\$121	6
RPPE5379	26	53"H panel connecting 79"H panel	Painted	\$127	7
RPPE6168	7	61"H panel connecting 68"H panel	Painted	\$117	5
RPPE6179	18	61"H panel connecting 79"H panel	Painted	\$124	7
RPPE6879	11	68"H panel connecting 79"H panel	Painted	\$119	6

Catalog Number	Length	Panels being joined	Trim Finish	List Price	Ship Weight
<b>Round Post Fabric Extensions</b>					
RPFE3243	11	32"H panel connecting 43"H panel	Fabric	\$140	6
RPFE3253	21	32"H panel connecting 53"H panel	Fabric	\$145	7
RPFE3261	29	32"H panel connecting 61"H panel	Fabric	\$148	7
RPFE3268	36	32"H panel connecting 68"H panel	Fabric	\$150	7
RPFE3279	47	32"H panel connecting 79"H panel	Fabric	\$154	8
RPFE4353	10	43"H panel connecting 53"H panel	Fabric	\$134	6
RPFE4361	18	43"H panel connecting 61"H panel	Fabric	\$142	6
RPFE4368	25	43"H panel connecting 68"H panel	Fabric	\$147	7
RPFE4379	36	43"H panel connecting 79"H panel	Fabric	\$150	7
RPFE5361	8	53"H panel connecting 61"H panel	Fabric	\$132	5
RPFE5368	15	53"H panel connecting 68"H panel	Fabric	\$141	6
RPFE5379	26	53"H panel connecting 79"H panel	Fabric	\$147	7
RPFE6168	7	61"H panel connecting 68"H panel	Fabric	\$132	5
RPFE6179	18	61"H panel connecting 79"H panel	Fabric	\$142	7
RPFE6879	11	68"H panel connecting 79"H panel	Fabric	\$140	6

## Specify Product Information

### SPECIFIC PRODUCT INFORMATION

FT trim is used to join panels of different heights on a straight run. No posts are used, only FT trim and clips are needed. Extension posts are used in conjunction with the standard square and round post to join panels of different heights that angle at the joint. Extension post includes joining clips and top cap.

# Multi-Height Panel Connectors

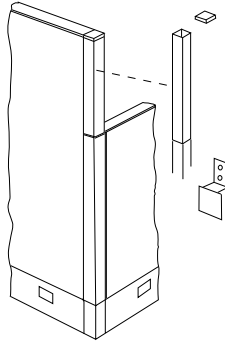

Catalog Number	Length	Panels being joined	Trim Finish	List Price	Ship Weight
<b>Square Post Painted Extensions</b>					
SPPE3243	11	32"H panel connecting 43"H panel	Painted	\$141	5
SPPE3253	21	32"H panel connecting 53"H panel	Painted	\$154	6
SPPE3261	29	32"H panel connecting 61"H panel	Painted	\$163	6
SPPE3268	36	32"H panel connecting 68"H panel	Painted	\$170	7
SPPE3279	47	32"H panel connecting 79"H panel	Painted	\$181	8
SPPE4353	10	43"H panel connecting 53"H panel	Painted	\$140	5
SPPE4361	18	43"H panel connecting 61"H panel	Painted	\$144	6
SPPE4368	25	43"H panel connecting 68"H panel	Painted	\$154	6
SPPE4379	36	43"H panel connecting 79"H panel	Painted	\$170	7
SPPE5361	8	53"H panel connecting 61"H panel	Painted	\$139	5
SPPE5368	15	53"H panel connecting 68"H panel	Painted	\$143	6
SPPE5379	26	53"H panel connecting 79"H panel	Painted	\$160	7
SPPE6168	7	61"H panel connecting 68"H panel	Painted	\$139	5
SPPE6179	18	61"H panel connecting 79"H panel	Painted	\$144	6
SPPE6879	11	68"H panel connecting 79"H panel	Painted	\$141	5

## Square Post Fabric Extensions

SPFE3243	11	32"H panel connecting 43"H panel	Fabric	\$156	5
SPFE3253	21	32"H panel connecting 53"H panel	Fabric	\$163	6
SPFE3261	29	32"H panel connecting 61"H panel	Fabric	\$177	6
SPFE3268	36	32"H panel connecting 68"H panel	Fabric	\$181	7
SPFE3279	47	32"H panel connecting 79"H panel	Fabric	\$194	8
SPFE4353	10	43"H panel connecting 53"H panel	Fabric	\$150	5
SPFE4361	18	43"H panel connecting 61"H panel	Fabric	\$160	6
SPFE4368	25	43"H panel connecting 68"H panel	Fabric	\$164	6
SPFE4379	36	43"H panel connecting 79"H panel	Fabric	\$181	7
SPFE5361	8	53"H panel connecting 61"H panel	Fabric	\$148	5
SPFE5368	15	53"H panel connecting 68"H panel	Fabric	\$158	6
SPFE5379	26	53"H panel connecting 79"H panel	Fabric	\$165	7
SPFE6168	7	61"H panel connecting 68"H panel	Fabric	\$148	5
SPFE6179	18	61"H panel connecting 79"H panel	Fabric	\$160	6
SPFE6879	11	68"H panel connecting 79"H panel	Fabric	\$156	5

### CLIP- M

Mid panel connector joins same height panels \$36 at location other than at post location.

## Specify Product Information

### SPECIFIC PRODUCT INFORMATION

FT trim is used to join panels of different heights on a straight run. No posts are used, only FT trim and clips are needed. Extension posts are used in conjunction with the standard square and round post to join panels of different heights that angle at the joint. Extension post includes joining clips and top cap.

# Electrical Components

Catalog Number	Description	List Price	Ship Weight
----------------	-------------	------------	-------------

### Ceiling Entry Power Post – Includes 1 SCA-18

RPPC32A	106" long painted post Joins with existing round post	\$419	10
RPPC43A	83" long painted post. Joins with existing round post	\$406	10
RPPC53A	72-13/16" long painted post	\$408	9
RPPC61A	62-5/16" long painted post	\$395	9
RPPC68A	54-13/16" long painted post	\$370	9
RPPC79A	47-5/16" long painted post	\$364	9
SPPC43A	83" long post Joins with existing square post	\$413	10
SPPC53A	72-13/16" long painted post	\$408	9
SPPC61A	62-5/16" long painted post	\$395	9
SPPC68A	54-13/16" long painted post	\$378	9
SPPC79A	47-5/16" long painted post	\$364	9

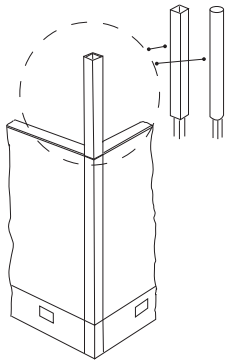

### Ceiling Entry Power Post – NO SCA INCLUDED

RPPC43	83" long painted post Joins with existing round post	\$239	10
RPPC53	72-13/16" long painted post	\$234	9
RPPC61	62-5/16" long painted post	\$220	9
RPPC68	54-13/16" long painted post	\$201	9
RPPC79	47-5/16" long painted post	\$188	9
SPPC43	83" long post Joins with existing square post	\$239	10
SPPC53	72-13/16" long painted post	\$234	9
SPPC61	62-5/16" long painted post	\$220	9
SPPC68	54-13/16" long painted post	\$201	9
SPPC79	47-5/16" long painted post	\$188	9

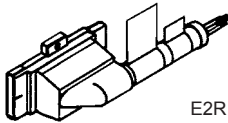
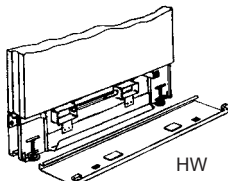
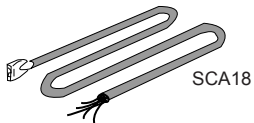

### Electrical Power Cables

SCA18	18 foot long flexible conduit	\$241	8
ICA17	17" joins power panel to panel– total length 21-3/4"	\$88	8
ICA19	19" joins power panel to post – total length 24"	\$88	8

### Hard Wired

Add suffix (HW)	Consult local electrical codes Includes 2 electrical boxes mounted to panel 1/2" conduit joining both boxes Does not include receptacles or wiring	\$110 per panel	
-----------------	--	-----------------	--

12" & 18" wide panels cannot be ordered hard wired with receptacle box

### Base Entry Power Starter Assembly Notes

E2R	Right hand	Liquidtite conduit (8' long)	\$230	5
E2L	Left hand	Supplies power to base of panel Plugs into any receptacle location	\$230	5

### Duplex Receptacles

DR1	Circuit 1 - Utility Circuit	State color: Grey, putty or black	\$47 each	1
DR2	Circuit 2 - Utility Circuit		\$47 each	1
DR3	Circuit 3 - Utility Circuit		\$47 each	1
IG4	Circuit 4 - Computer Circuit	Orange Only	\$47 each	1
	Isolated Ground			

### Desk Top Power / Communication Port

ECA2	8-1/8 x 4-5/8	Recessed in worksurface with self-closing lid Constructed of heavy gauge steel Power cord 6" long Duplex electrical outlet with RJ11/RJ45 voice-data connectors and faceplate Specify location for cutout when ordering worksurface Includes simplex receptacle in bottom for "daisy chaining"	\$373	4
ECA3		Mid panel & desk top communications port accepts up to 4 jacks (jacks included- specify style)	\$184	2
ECA4		Raceway communications port accepts up to two jacks (jack included - specify style)	\$86	2

• RJ11 for phone / RJ45 for Internet

# Rectangular Worksurfaces

Catalog Number	W x D	List Price	Ship Weight
<b>Straight – 19-5/8" deep w/support brackets</b>			
WS2420-TE	24 x 19-5/8	\$417	24
WS3020-TE	30 x 19-5/8	\$417	30
WS3620-TE	36 x 19-5/8	\$417	36
WS4220-TE	42 x 19-5/8	\$422	42
WS4820-TE	48 x 19-5/8	\$429	48
WS5420-TE	54 x 19-5/8	\$440	54
WS6020-TE	60 x 19-5/8	\$468	60
WS6620-TE	66 x 19-5/8	\$516	66
WS7220-TE	72 x 19-5/8	\$561	72

Catalog Number	W x D	List Price	Ship Weight
<b>Straight – 24" deep w/support brackets</b>			
WS2424-TE	24 x 24	\$472	24
WS3024-TE	30 x 24	\$479	30
WS3624-TE	36 x 24	\$493	36
WS4224-TE	42 x 24	\$506	42
WS4824-TE	48 x 24	\$516	48
WS5424-TE	54 x 24	\$541	54
WS6024-TE	60 x 24	\$585	60
WS6624-TE	66 x 24	\$628	66
WS7224-TE	72 x 24	\$672	72

Catalog Number	W x D	List Price	Ship Weight
<b>Straight – 30" deep w/support brackets</b>			
WS2430-TE	24 x 30	\$472	30
WS3030-TE	30 x 30	\$479	38
WS3630-TE	36 x 30	\$493	45
WS4230-TE	42 x 30	\$506	53
WS4830-TE	48 x 30	\$516	60
WS5430-TE	54 x 30	\$541	67
WS6030-TE	60 x 30	\$585	75
WS6630-TE	66 x 30	\$628	83
WS7230-TE	72 x 30	\$672	90

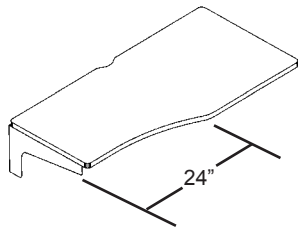
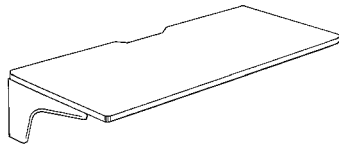

Catalog Number	W x D	List Price	Ship Weight
<b>Curved – 24"/30" deep w/support brackets</b>			
WS422430-TE	42 x 24 x 30	\$535	42
WS482430-TE	48 x 24 x 30	\$551	48
WS542430-TE	54 x 24 x 30	\$590	54
WS602430-TE	60 x 24 x 30	\$621	60
WS662430-TE	66 x 24 x 30	\$660	66
WS722430-TE	72 x 24 x 30	\$704	72

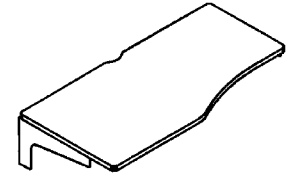

Catalog Number	W x D	List Price	Ship Weight
<b>Curved – 30"/24" deep w/support brackets</b>			
WS423024-TE	42 x 30 x 24	\$535	53
WS483024-TE	48 x 30 x 24	\$551	60
WS543024-TE	54 x 30 x 24	\$590	67
WS603024-TE	60 x 30 x 24	\$621	75
WS663024-TE	66 x 30 x 24	\$660	83
WS723024-TE	72 x 30 x 24	\$704	90

**Specify Product Information**

\*Special width worksurfaces are available up to 97". Add \$13.00/inch to list price. (For special widths greater than 97"W, consult factory for pricing.)

High pressure laminate worksurface with vinyl T-edge molding includes pair of position locking cantilevered support brackets which mount into panel uprights. **If support bracket is not needed, specify without (-NB, -NL, -NR; add as suffix to item number) and deduct \$44 per bracket from list.** "-NB" is no brackets, "-NL" is no left bracket included, "-NR" is no right bracket included.

# Corner & Convergent Worksurfaces

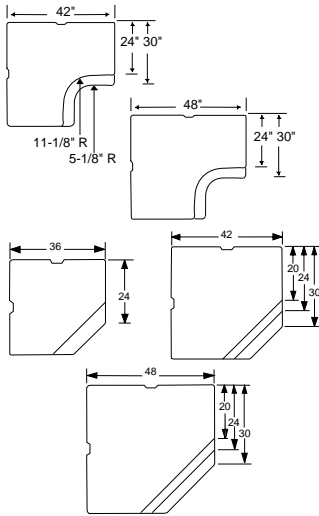

See page 65 for actual front diagonal dimensions.

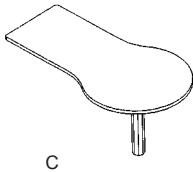
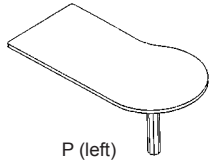
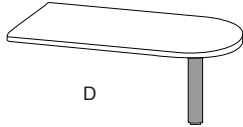
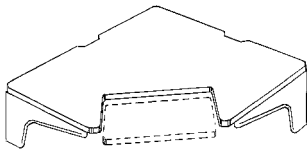

Catalog Number	W x D	Description	List Price	Ship Weight
<b>L-Corner w/Support Brackets</b>				
CWSL3624-TE	36 x 24		\$784	57
CWSL4224-TE	42 x 24		\$784	60
CWSL4230-TE	42 x 30		\$796	63
CWSL4824-TE	48 x 24		\$825	73
CWSL4830-TE	48 x 30		\$840	81

<b>5-Sided Corner w/Support Brackets</b>				
CWS3624-TE	36 x 24		\$653	60
CWS4220-TE	42 x 20		\$653	64
CWS4224-TE	42 x 24		\$679	64
CWS4230-TE	42 x 30		\$688	65
CWS4820-TE	48 x 20		\$734	60
CWS4824-TE	48 x 24		\$771	60
CWS4830-TE	48 x 30		\$796	61

5-Sided Corner	w/Support Brackets	w/Keyboard Cutout	List Price	Ship Weight
CWS4220KA-TE	42 x 20	Worksurface has cut out	\$679	75
CWS4224KA-TE	42 x 24	for adjustable keyboard,	\$697	75
CWS4820KA-TE	48 x 20	order Keyboard separate.	\$753	71
CWS4824KA-TE	48 x 24		\$784	71
CWS4830KA-TE	48 x 30		\$809	72

<b>Convergent Worksurface (includes COL-SUP29)</b>				
DWS6030-TE	30 x 60		\$835	85
DWS6630-TE	30 x 66	"D" Shape	\$862	93
DWS7230-TE	30 x 72		\$882	100
PL603036-TE	30 x 60	36" conference diameter	\$849	95
PL663036-TE	30 x 66	36" conference diameter	\$864	103
PL723036-TE	30 x 72	36" conference diameter	\$885	110
PL723642-TE	36 x 72	42" conference diameter	\$905	115
PR603036-TE	30 x 60	36" conference diameter	\$849	95
PR663036-TE	30 x 66	36" conference diameter	\$864	103
PR723036-TE	30 x 72	36" conference diameter	\$885	110
PR723642-TE	36 x 72	42" conference diameter	\$905	115
CG603036-TE	30 x 60	36" conference diameter	\$849	95
CG663036-TE	30 x 66	36" conference diameter	\$864	103
CG723036-TE	30 x 72	36" conference diameter	\$885	110
CG723642-TE	36 x 72	42" conference diameter	\$905	115

<b>Support Column for Convergents</b>				
COL-SUP-29		Painted support column with glide. 29" high	\$175	16

## Specify Product Information

High pressure laminate worksurface with vinyl T-edge molding. Corner worksurfaces include one #CW back bracket and a pair of position locking cantilevered support brackets which mount into panel uprights. Corner surfaces have two cord reliefs centered on backsides of worksurface. Convergent worksurfaces have no cord reliefs or grommets.



# Counter Transaction Worksurfaces

Catalog Number	Top W x D	Description	List Price	Ship Weight
----------------	-----------	-------------	------------	-------------

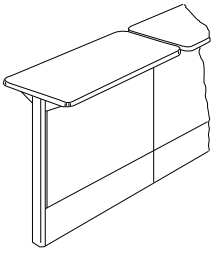

Straight Run w/Support Brackets				
CS24-TE	24 x 15		\$324	15
CS30-TE	30 x 15		\$338	19
CS36-TE	36 x 15		\$364	23
CS42-TE	42 x 15		\$384	27
CS48-TE	48 x 15		\$400	30
CS54-TE	54 x 15		\$419	34
CS60-TE	60 x 15		\$436	38
CS66-TE	66 x 15		\$450	42
CS72-TE	72 x 15		\$468	46

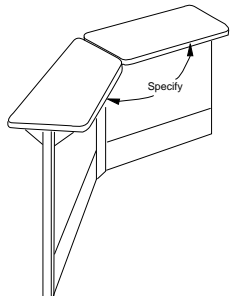

Angular w/Support Brackets				
ACS24*-TE	24 x 15		\$419	15
ACS30*-TE	30 x 15		\$436	19
ACS36*-TE	36 x 15		\$450	23
ACS42*-TE	42 x 15	For a 90° angled run (one side angled).	\$482	27
ACS48*-TE	48 x 15		\$500	30
ACS54*-TE	54 x 15		\$523	34
ACS60*-TE	60 x 15		\$537	38
ACS66*-TE	66 x 15		\$556	42
ACS72*-TE	72 x 15		\$568	46

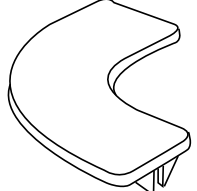

**NOTE:** Where asterisk (\*) is denoted, please substitute a L or R for left or right angle.  
Any angle may be cut. Indicate desired angle on order. See illustration below.

Curved w/Support Brackets				
RCS24-TE	Uses three small straight panels and round posts for base.	\$433	33	

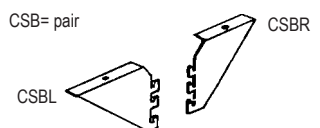
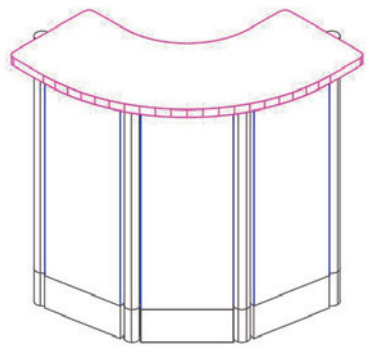
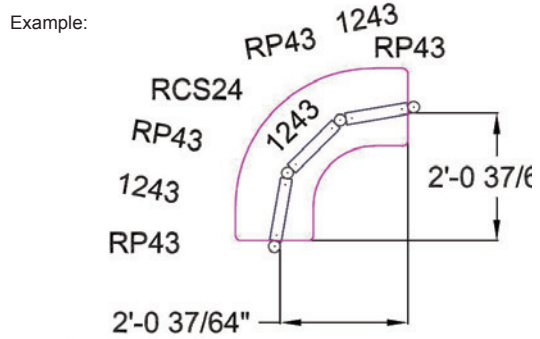
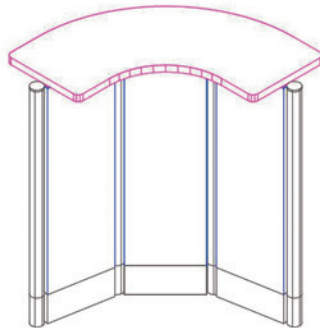

"CSB" Straight Transactional Support Brackets				
CSB	Extra brackets. To attach transactional surface with straight end.	\$67 per pair	3	

"MCSB" Mitered Transactional Support Brackets				
MCSB	Extra brackets.	\$97 per pair	6	
MCSB*	Extra bracket. Angled support bracket to attach transactional surface with miter on one end. Note: When ordering, angled brackets can be mixed with straight brackets. Order appropriate angled side. Example: 1-MCSB (left), 1-CSB (right). State color when ordering.	\$65 each	3	

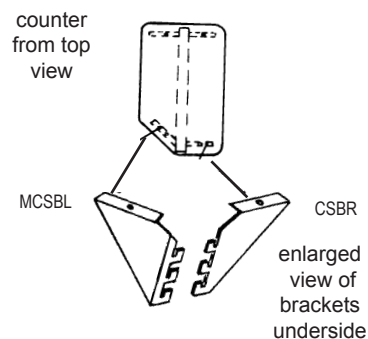

# Special Worksurfaces

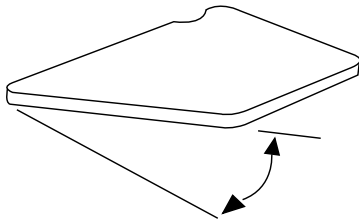

Catalog Number	Top W x D	Description	List Price	Ship Weight
<b>Angular Worksurface w/Support Brackets</b>				
AWS2424-TE	24 x 24	Reversible	\$667	24
AWS3624-TE	36 x 24	Worksurface laminated on both sides.	\$685	36
AWS4224-TE	42 x 24		\$692	42
AWS4824-TE	48 x 24		\$711	48
AWS5424-TE	54 x 24		\$722	54
AWS6024-TE	60 x 24		\$736	60
AWS6624-TE	66 x 24		\$748	66
AWS7224-TE	72 x 24		\$773	72
<hr/>				
AWS3030-TE	30 x 30	Reversible	\$711	35
AWS3630-TE	36 x 30	Worksurface laminated on both sides.	\$721	42
AWS4230-TE	42 x 30		\$728	48
AWS4830-TE	48 x 30		\$745	54
AWS5430-TE	54 x 30		\$757	64
AWS6030-TE	60 x 30		\$772	70
AWS6630-TE	66 x 30		\$783	76
AWS7230-TE	72 x 30		\$807	82

Indicate standard worksurface (WS) size, which side angle cut, and desired angle.

### AWS SPECIFICATION NOTES & DRAWING MUST ACCOMPANY ORDER:

Sample order: "AWS 6030 (60W x 30D) standard WS, 30° angle cut on the left side. See drawing."

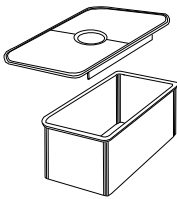

### Grommets For Worksurfaces

1-GRR	3" x 1-1/2"	Grommet is black hard plastic finish. Allows cords to pass thru worksurface. Factory installed only.	\$57 each	1
-------	-------------	--	-----------	---

### Specify Product Information

\*Special width worksurfaces are available up to 97". Add \$13.00/inch to list price. (For special widths greater than 97" W consult factory for pricing.)

High pressure laminate worksurface with T-edge molding includes pair of position locking cantilevered support brackets which mount into panel uprights. (If support bracket is not needed, specify without and deduct \$44 per bracket from list.) One cord relief centered on back of worksurface.

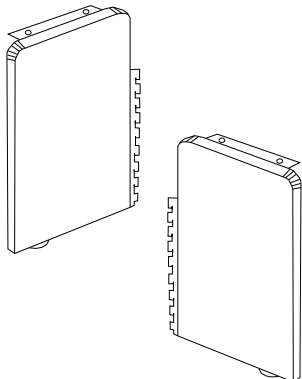

Catalog Number	D x H	Description	List Price	Ship Weight
<b>29" high laminate right end with T - Mold edge</b>				
SEP2029R-TE	20 x 29		\$408	20
SEP2429R-TE	24 x 29	Laminated surface (interior and exterior)	\$436	26
SEP3029R-TE	30 x 29		\$448	32
<hr/>				
<b>29" high laminate left end with T - Mold edge</b>				
SEP2029L-TE	20 x 29		\$408	20-TE
SEP2429L-TE	24 x 29	Laminated surface (interior and exterior)	\$436	26
SEP3029L-TE	30 x 29		\$448	32

# Support Brackets for Worksurfaces

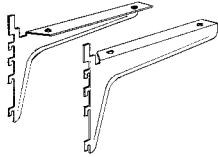

Catalog Number	Description	List Price	Ship Weight
----------------	-------------	------------	-------------

## Straight Run Worksurface Brackets

SSBML	Left bracket Used with 19-5/8"D top.	\$136 each	4
SSBMR	Right bracket	\$136 each	4
SSBL	Left bracket Used with 24-30"D top.	\$165 each	5
SSBR	Right bracket	\$165 each	5

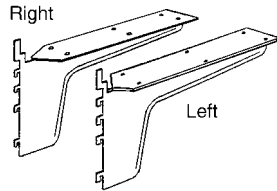

SSLL	Left bracket	Used with L-returns or when joining worksurfaces together in-line. Top flange in both directions.	\$165 each	5
SSLR	Right bracket		\$165 each	5

Note: SSBM, SSB and SSL brackets are cantilevered brackets which lock into panel uprites.

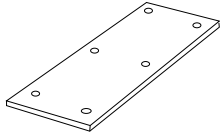

FC20	20" bracket	Flat connecting plate. Joins tops of the same height.	\$55 each	2
FC24-30	24-30" bracket		\$55 each	2

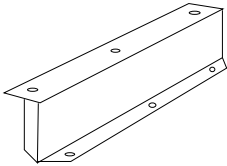

ZC20	20" bracket	"Z" connecting plate. Joins tops with 3" offset.	\$65 each	2
ZC24	24" bracket		\$65 each	2

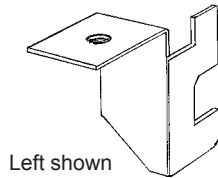

## Corner and Radiused Worksurface Brackets

CWSBBL	Bracket bends to right.	Corner & radius bracket.	\$35 each	1
CWSBBR	Bracket bends to left.	Corner & radius bracket.	\$35 each	1
ED-10PL	Support Bracket	Left	\$43 each	1
ED-10PR	Support Bracket	Right	\$43 each	1

# Ceiling Track Bracket

CAB96	Bracket Attaches Panel To Ceiling	\$225
CAB96-CORNER	Corner Bracket Bracket ForCeiling	\$208

# Overhead Storage

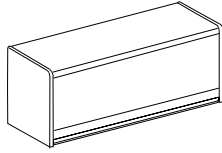

Catalog Number	Dimensions W x D x H	Description	Maximum Wft Capacity	List Price	Ship Weight
<b>Steel Receding Door Unit (RDU) - Recedes Inside Painted Steel Door, No Lock</b>					
RDUS24	24 x 15 x 16-1/2		111	\$729	42
RDUS30	30 x 15 x 16-1/2		141	\$729	47
RDUS36	36 x 15 x 16-1/2		171	\$753	52
RDUS42	42 x 15 x 16-1/2		202	\$780	62
RDUS48	48 x 15 x 16-1/2		232	\$844	72
RDUS54	54 x 15 x 16-1/2		262	\$875	77
RDUS60	60 x 15 x 16-1/2		292	\$912	82

## RDU Lock

LK	24" - 60" wide	Add LK to suffix. General overhead lock. Two (2) keys provided. Factory installed only.	\$40	10
----	----------------	--	------	----

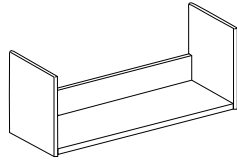

## Steel Bookshelf, High Sided

BS24HS	24 x 15 x 16-1/2	111	\$429	20
BS30HS	30 x 15 x 16-1/2	141	\$438	21
BS36HS	36 x 15 x 16-1/2	171	\$448	23
BS42HS	42 x 15 x 16-1/2	202	\$465	25
BS48HS	48 x 15 x 16-1/2	232	\$477	27
BS54HS	54 x 15 x 16-1/2	262	\$489	29
BS60HS	60 x 15 x 16-1/2	292	\$498	31

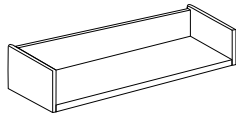

## Steel Bookshelf, Low Sided

BS24LS	24 x 15 x 7	111	\$406	19
BS30LS	30 x 15 x 7	141	\$418	20
BS36LS	36 x 15 x 7	171	\$429	22
BS42LS	42 x 15 x 7	202	\$438	24
BS48LS	48 x 15 x 7	232	\$448	26
BS54LS	54 x 15 x 7	262	\$461	28
BS60LS	60 x 15 x 7	292	\$472	30

## Corner Shelf – Wood Core

Laminated (top & bottom) 1-1/4" wood core shelf

SE – Self-edge all sides

CS3615-SE	36 x 15	171	\$440	39
CS4215-SE	42 x 15	202	\$472	42
CS4815-SE	48 x 15	232	\$506	46

TE – T-edge molding all sides

CS3615-TE	36 x 15	171	\$461	39
CS4215-TE	42 x 15	202	\$489	42
CS4815-TE	48 x 15	232	\$523	46

Includes support brackets

## Specify Product Information

### SPECIFIC PRODUCT INFORMATION

Steel units have recessed full width door pulls. RDU interior dimensions 13" H x 12" D. Steel bookshelves are 13" deep. All units include mounting brackets. Standard task light mounts under any unit (except corner shelf).

# Mounting Brackets

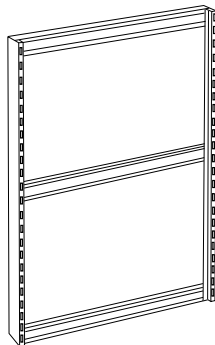
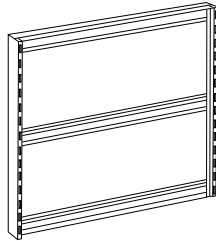
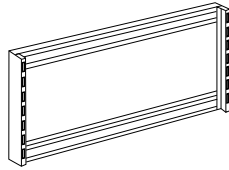
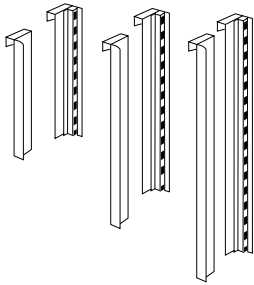

Catalog Number	Size	Description	List Price	Ship Weight
<b>Bookshelf and Receding Door Unit Hanging Brackets</b>				
TRB1	16-1/2"	Attaches to panels top rail. Mounts (1) single unit to panel.	\$148	8
TRB1-5	24-9/16"	Mounts (1-1/2) unit to panel.	\$156	9
TRB2	32-5/8"	Mounts (2) 16-1/2"H RDU units or smaller to panel.	\$170	10

Note: Brackets can be used across corners. Bookshelves and RDU's hang diagonally.

<b>Wall Mount Brackets* to Hang Bookshelf, RDU, Tackboards, Surfaces, Organizer Racks</b>						
			H	W		
HWT24	24" W - Single ht.	Mounts (1) single unit to wall.	16-1/2	24 7/32	\$121	8
HWT24-2	24" W - Double ht.	Mounts (2) single units to wall.	33	24-7/32	\$165	10
HWT24-3	24" W - Triple ht.	Mounts (3) single units to wall.	49-1/2	24 -7/32	\$190	13
HWT30	30" W - Single ht.	Mounts (1) single unit to wall.	16-1/2	30-7/32	\$134	11
HWT30-2	30" W - Double ht.	Mounts (2) single units to wall.	33	30-7/32	\$179	13
HWT30-3	30" W - Triple ht.	Mounts (3) single units to wall.	49-1/2	30-7/32	\$209	16
HWT36	36" W - Single ht.	Mounts (1) single unit to wall.	16-1/2	36-7/32	\$134	14
HWT36-2	36" W - Double ht.	Mounts (2) single units to wall.	33	36-7/32	\$179	16
HWT36-3	36" W - Triple ht.	Mounts (3) single units to wall.	49-1/2	36-7/32	\$209	19
HWT42	42" W - Single ht.	Mounts (1) single unit to wall.	16-1/2	42-15/32	\$143	17
HWT42-2	42" W - Double ht.	Mounts (2) single units to wall.	33	42-15/32	\$181	19
HWT42-3	42" W - Triple ht.	Mounts (3) single units to wall.	49-1/2	42-15/32	\$227	22
HWT48	48" W - Single ht.	Mounts (1) single unit to wall.	16-1/2	48-15/32	\$148	20
HWT48-2	48" W - Double ht.	Mounts (2) single units to wall.	33	48-15/32	\$190	22
HWT48-3	48" W - Triple ht.	Mounts (3) single units to wall.	49-1/2	48-15/32	\$230	25
HWT54	54" W - Single ht.	Mounts (1) single unit to wall.	16-1/2	54-15/32	\$150	23
HWT54-2	54" W - Double ht.	Mounts (2) single units to wall.	33	54-15/32	\$194	25
HWT54-3	54" W - Triple ht.	Mounts (3) single units to wall.	49-1/2	54-15/32	\$241	28
HWT60	60" W - Single ht.	Mounts (1) single unit to wall.	16-1/2	60-15/32	\$150	23
HWT60-2	60" W - Double ht.	Mounts (2) single units to wall.	33	60-15/32	\$196	25
HWT60-3	60" W - Triple ht.	Mounts (3) single units to wall.	49-1/2	60-15/36	\$241	28

## Specify Product Information

### SPECIFIC PRODUCT INFORMATION

TRB painted brackets will allow receding door units and bookshelves to be mounted anywhere on the panel when not positioned in panel top rail channel. With the TRB brackets you can put a storage unit anywhere on the panel, even diagonally at corners. HWT painted brackets allow upper storage units and tackboards to mount to the wall.

# Accessories & Task Lights

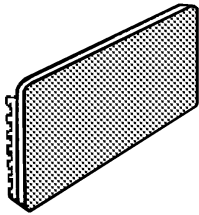

Catalog Number	Dimensions	Description	List Price	Ship Weight
<b>Fabric Covered Tackboards</b>				
TB24	24"W x 15"H	Attaches into vertical uprights of panel	\$340	3
TB30	30"W x 15"H	or Wall Mount Brackets.	\$360	4
TB36	36"W x 15"H	1/2" Thick.	\$376	5
TB42	42"W x 15"H		\$388	5
TB48	48"W x 15"H		\$400	8
TB54	54"W x 15"H		\$406	8
TB60	60"W x 15"H		\$433	8

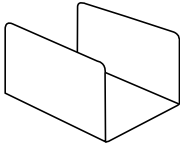

Divider	W x D x H	Description	List Price	Ship Weight
<b>DIV9</b>	9 x 11-1/2 x 7-1/2	Divider rests on bookshelves or inside receding door units. 18 gauge steel construction.	\$59	5

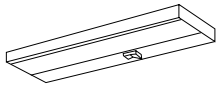

Full Height Riser Task Light  
(Bookshelf or RDU)  
Provides energy efficient illumination.

Divider	W x D x H	Description	List Price	Ship Weight
	21.5"	TL24UM	\$216	10
	33.5"	TL36UM	\$248	12
	45.5"	TL48UM	\$266	14
	57.5"	TL60UM	\$282	16

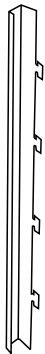

Cord Manager For Lights	Dimensions	Description	List Price	Ship Weight
FC2-5	30" long	Fabric covered	\$90	3

**For Pedestals, Center Drawers, Keyboard Trays and other Accessories, please see pages 18-22.**